



## Premium-Zerspanungswerkzeuge

Dreh-, Fräs- und Bohrwerkzeuge für Wendeschneidplatten  
*Turning, milling and drilling tools for indexable inserts*



## **Das Unternehmen**

*Die TAM-Firmengruppe wurde 1993 mit Firmensitz in Deutschland gegründet und hat sich heute mit der Marke GOLDBERG® hervorragend am Markt etabliert. Spezialisiert auf Zerspanungswerkzeuge steht sie dabei international für höchste Qualität und Präzision.*

*Unser Produktsortiment umfasst ein sehr umfangreiches Lieferprogramm an modernsten Zerspanungswerkzeugen für Dreh-, Fräs- und Bohroperationen für die Metall verarbeitende Industrie. Das erlaubt es, uns jeder spezifischen Aufgabe mit Hilfe neuester Technologien zu stellen und höchst flexibel auf Ihre spezifischen Wünsche einzugehen. Dabei sind wir stets am Puls der Zeit, offen für Innovationen und bekannt für die Lösung individueller Problemstellungen.*

*Wir sind mit den Anforderungen in der Metall verarbeitenden Industrie bestens vertraut. Sie als Kunde profitieren von einem hohen Maß an Fachkompetenz, das kontinuierlich in alle Lösungen einfließt – konsequent verstärkt durch ein internes Qualitätskontrollsystem, welches eine Performance für höchste Anforderungen gewährleistet. Ergebnis unserer innovativen Technik sind Produkte, die sich durch präzise Verarbeitung, eine einzigartige Verschleißfestigkeit und damit hervorragende Standzeiten Ihrer Werkzeuge auszeichnen. Ihr Vorteil: ein langjähriger Einsatz, der zu geringeren Werkzeugkosten und zu einer höheren Auslastung Ihrer Produktion führt.*

*Auch sind wir Ihr zuverlässiger Partner, wenn es um die Integration in Ihr Supply-Chain-Management geht: Unser eigens entwickeltes Programm GOLDBERG®-XPRESS CARGO dient der optimierten Zusammenarbeit mit unseren und Ihren Logistikpartnern und gewährleistet die termingenaue, zuverlässige Lieferung der Werkzeuge. Das steigert die Effizienz in Ihrer Logistik – Wartezeiten werden vermieden.*

*Neben einem Höchstmaß an Leistungsfähigkeit und Qualitätsniveau gehört selbstverständlich auch eine faire Preispolitik zu unseren Prioritäten.*

***Kontaktieren Sie uns – wir sind gespannt auf Ihre Herausforderungen!***





## ***The company***

*GOLDBERG® is a brand of TAM Group, that was founded in Germany in the year 1993. As a specialist for cutting tools, GOLDBERG® products are internationally recognized for high performance tooling.*

*The product range encompasses a huge variety of cutting tools for turning, milling and drilling operations for the metal working industry. All our innovations are introduced only after having passed the internal quality control system so that high performance can be guaranteed.*

*Your advantage: longer tool life that leads to lower tooling cost and a higher utilization of production capacity.*

*The focus on the latest technological developments as well as our customer oriented culture allow us to respond to our customers specific requirements so that engineering of custom made tools is also one of our areas of expertise.*

*Besides of highly innovative tools and an excellent customer service, a fair pricing policy is one of our priorities.*

***Contact us – We look forward to your challenges!***

# Kompetenz & Leistungsfähigkeit für höchste Anforderungen / *Competence and performance for highest requirements*

## Inhaltsverzeichnis / *Contents*

### **Drehen/Turning – GOLDturn**

#### *Drehhalter für die Außenbearbeitung / Turning toolholders for external machining*

T & C-System	S.6 - S.14
M-System	S.15 - S.17
S-System	S.18 - S.29
Drehhalter für Langdrehautomaten / Toolholders for automatic lathes	S.30 - S.33
P-System	S.34 - S.42

#### *Drehhalter für die Innenbearbeitung / Turning toolholders for internal machining*

T & C-System	S.44 - S.49
M-System	S.50 - S.54
S-System	S.55 - S.65
P-System	S.66 - S.70
Gewindedrehhalter / Threading toolholders	S.71 - S.74

### **Bohren/Drilling – GOLDdrilling**

Kurzklemmhalter / Cartridges	S.75 - S.81
Wendeplattenbohrer / U-Drills for indexable inserts	S.82 - S.90

### **Fräsen/Milling – GOLDmilling**

Einschraub- und Schaftfräswerkzeuge / Screw-in and end mills	S.91 - S.98
Eck- und Planmesserköpfe / Shoulder and face milling cutters	S.99 - S.108
Scheibenfräser / Slot disc milling	S.109
T-Nutenfräser / T-Slot milling cutters	S.110



Drehhalter für die Innen- und Außenbearbeitung/  
*Toolholders for internal and external machining*



**1**

<b>P</b> 1	<b>S</b> 2	<b>K</b> 3	<b>N</b> 4	<b>R</b> 5
---------------	---------------	---------------	---------------	---------------

**1** Art der Schneidplattenbefestigung / Type of insert mounting

von oben gespannt/ top clamping	von oben über die Bohrung gespannt/ top and hole clamping	von oben und über die Bohrung gespannt/ top and hole clamping	über die Bohrung gespannt/ hole clamping	über die Bohrung geschraubt/ screw clamping
<b>C</b>	<b>T</b>	<b>M</b>	<b>P</b>	<b>S</b>

**2** Grundform der Wendeschneidplatte / Basic shape of indexable insert

<b>C</b>	<b>D</b>	<b>E</b>	<b>K</b>
<b>L</b>	<b>R</b>	<b>S</b>	<b>T</b>
<b>V</b>	<b>W</b>	<b>A</b>	<b>B</b>
<b>H</b>	<b>M</b>	<b>O</b>	<b>P</b>

**3** Anstellwinkel / Approach angle

<b>B</b>	<b>D</b>	<b>E</b>	<b>F</b>	<b>G</b>	<b>J</b>
<b>K</b>	<b>L</b>	<b>M</b>	<b>N</b>	<b>R</b>	<b>S</b>
<b>T</b>	<b>V</b>	<b>Y</b>	<b>Z</b>		

**4** Freiwinkel der Wendeschneidplatte / Indexable insert clearance angle

<b>A</b>	<b>B</b>	<b>C</b>
<b>D</b>	<b>E</b>	<b>F</b>
<b>G</b>	<b>N</b>	<b>P</b>

**6** **25** **25** - **M** **12** **C**

**5** Drehhalterausführung / Orientation of turning toolholder

<b>L</b>	<b>N</b>	<b>R</b>

**6** Drehhalterhöhe (mm) / Turning toolholder height (mm)

**7** Schaftbreite / Shank width

**8** Drehhalterlänge (mm) / Turning toolholder length (mm)

A - 32	H - 100	Q - 180	x-special
B - 40	J - 110	R - 200	
C - 50	K - 125	S - 250	
D - 60	L - 140	T - 300	
E - 70	M - 150	U - 350	
F - 80	N - 160	V - 400	
G - 90	P - 170	W - 450	

**9** Länge der Schneidkante (mm) / Length of cutting edge (mm)

**10** Spannpratze / Clamping wedge



# T & C-System Außendrehhalter / *T & C-System external toolholders*



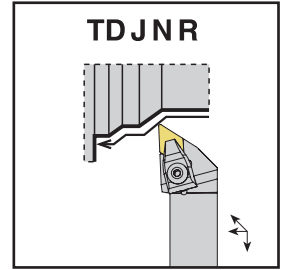
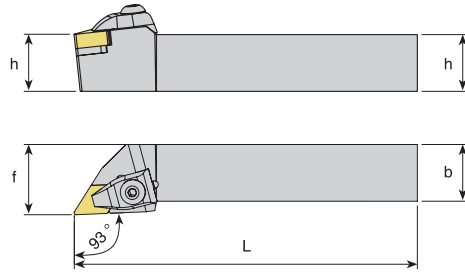

Bezeichnung Designation	Abmessungen (mm) Dimensions (mm)				Wendeplatte Insert	Ersatzteile Spare parts													
	h	b	L	f		Spannpratze(SP) Clamp	Schraube für SP Screw for clamp	Unterlage (UL) Shim	Schraube für UL Screw for shim	Druckfeder Pressure spring	Unterlegscheibe Washer	Winkelschlüssel Allen key							
<b>TDJNR/L 1616 H 11</b>	16	16	100	20															
<b>2020 K 11</b>	20	20	125	25									<b>DNM. 11 04..</b>	002001	003001	001028	004004	-	
<b>2525 M 11</b>	25	25	150	32															
<b>2020 K 15</b>	20	20	125	25															
<b>2525 M 15</b>	25	25	150	32									<b>DNM. 15 06..</b>	002002	003002	001030	004002	006001	005001 017003
<b>3232 P 15</b>	32	32	170	40															
<b>4040 S 15</b>	40	40	250	50															
<b>5050 S 15</b>	50	50	250	63															

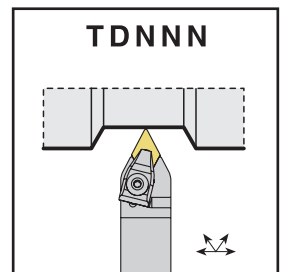
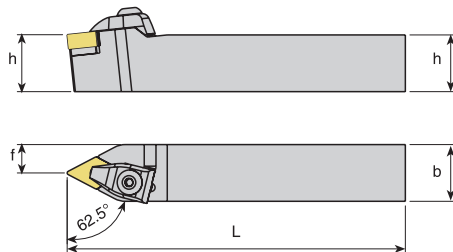

Bezeichnung Designation	Abmessungen (mm) Dimensions (mm)				Wendeplatte Insert	Ersatzteile Spare parts													
	h	b	L	f		Spannpratze(SP) Clamp	Schraube für SP Screw for clamp	Unterlage (UL) Shim	Schraube für UL Screw for shim	Druckfeder Pressure spring	Unterlegscheibe Washer	Winkelschlüssel Allen key							
<b>TDNNN 1616 H 11</b>	16	16	100	8															
<b>2020 K 11</b>	20	20	125	10									<b>DNM. 11 04..</b>	002001	003001	001028	004004	-	
<b>2525 M 11</b>	25	25	150	12.5															
<b>2020 K 15</b>	20	20	125	10															
<b>2525 M 15</b>	25	25	150	12.5									<b>DNM. 15 06..</b>	002002	003002	001030	004002	006001	005001 017003
<b>3232 P 15</b>	32	32	170	16															
<b>4040 S 15</b>	40	40	250	20															
<b>5050 S 15</b>	50	50	250	25															

Bestellbeispiel/Ordering example: 1 Stk./pcs. TDJNR 1616 H11



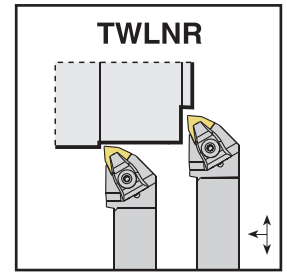
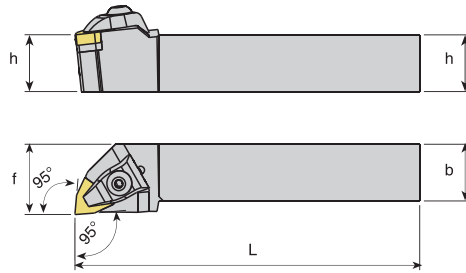
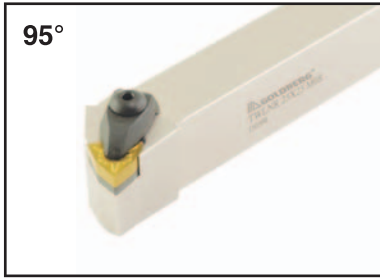

Bezeichnung Designation	Abmessungen (mm) Dimensions (mm)				Wendeplatte Insert	Ersatzteile Spare parts						
	h	b	L	f		Spannpratze (SP) Clamp	Schraube für SP Screw for clamp	Unterlage (UL) Shim	Schraube für UL Screw for shim	Druckfeder Pressure spring	Unterlegscheibe Washer	Winkelschlüssel Allen key
<b>TWLNR/L 1616 H 06</b>	16	16	100	20			002001	003001	001018	004001	-	
<b>2020 K 06</b>	20	20	125	25								
<b>2525 M06</b>	25	25	150	32								
<b>2020 K 08</b>	20	20	125	25		002002	003002	001017	004002	006001	005001	017003
<b>2525 M08</b>	25	25	150	32								
<b>3232 P 08</b>	32	32	170	40								
<b>4040 S 08</b>	40	40	250	50								
<b>5050 S 08</b>	50	50	250	63								

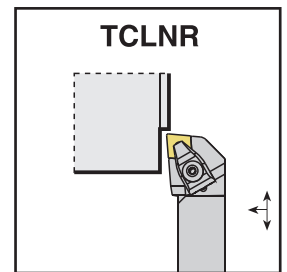
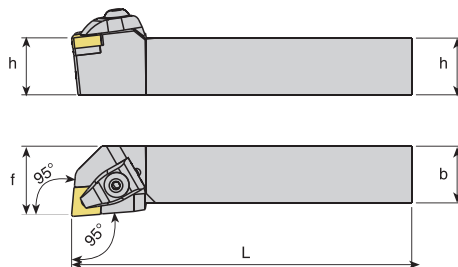

Bezeichnung Designation	Abmessungen (mm) Dimensions (mm)				Wendeplatte Insert	Ersatzteile Spare parts						
	h	b	L	f		Spannpratze (SP) Clamp	Schraube für SP Screw for clamp	Unterlage (UL) Shim	Schraube für UL Screw for shim	Druckfeder Pressure spring	Unterlegscheibe Washer	Winkelschlüssel Allen key
<b>TCLNR/L 2020 K 12</b>	20	20	125	25		002002	003002	001013	004002	006001	005001	017003
<b>2525 M12</b>	25	25	150	32								
<b>3232 P 12</b>	32	32	170	40								
<b>4040 S 12</b>	40	40	250	50								
<b>5050 S 12</b>	50	50	250	63								
<b>2525 M16</b>	25	25	150	32		002004	003005	001014	003010	-	-	017004
<b>3232 P 16</b>	32	32	170	40								

Bestellbeispiel/Ordering example: 1 Stk./pcs. TCLNR 2020 K12

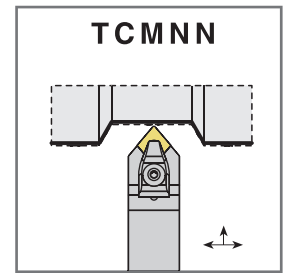
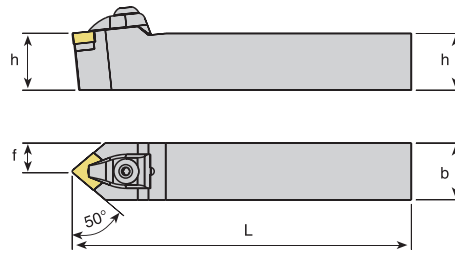

Bezeichnung Designation	Abmessungen (mm) Dimensions (mm)				Wendeplatte Insert	Ersatzteile Spare parts						
	h	b	L	f		Spannpratze (SP) Clamp	Schraube für SP Screw for clamp	Unterlage (UL) Shim	Schraube für UL Screw for shim	Druckfeder Pressure spring	Unterlegscheibe Washer	Winkelschlüssel Allen key
<b>TCMNN 1616 H 12</b>	16	16	100	8	<b>CNM. 12 04..</b>							
<b>2020 K 12</b>	20	20	125	10								
<b>2525 M12</b>	25	25	150	12.5								
<b>3232 P 12</b>	32	32	170	16								
<b>3232 P 16</b>	32	32	170	16	<b>CNM. 16 06..</b>							
<b>4040 S 16</b>	40	40	250	20								

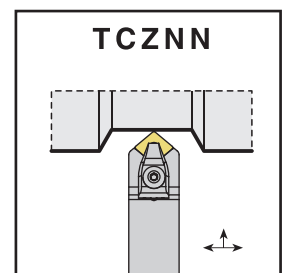
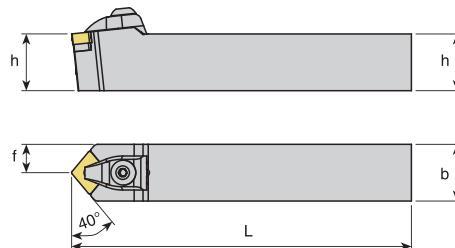

Bezeichnung Designation	Abmessungen (mm) Dimensions (mm)				Wendeplatte Insert	Ersatzteile Spare parts						
	h	b	L	f		Spannpratze (SP) Clamp	Schraube für SP Screw for clamp	Unterlage (UL) Shim	Schraube für UL Screw for shim	Druckfeder Pressure spring	Unterlegscheibe Washer	Winkelschlüssel Allen key
<b>TCZNN 2020 K 12</b>	20	20	125	10	<b>CNM. 12 04..</b>							
<b>2525 M12</b>	25	25	150	12.5								
<b>3232 P 12</b>	32	32	170	16								

Bestellbeispiel/Ordering example: 1 Stk./pcs. TCZNN 2020 K12



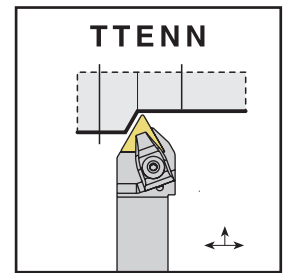
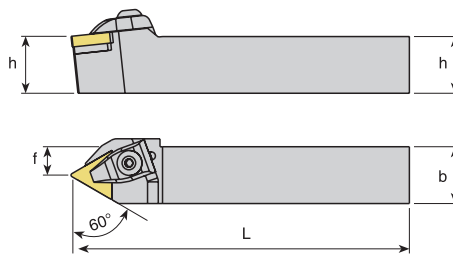

Bezeichnung Designation	Abmessungen (mm) Dimensions (mm)				Wendeplatte Insert	Ersatzteile Spare parts														
	h	b	L	f		Spannpratze (SP) Clamp	Schraube für SP Screw for clamp	Unterlage (UL) Shim	Schraube für UL Screw for shim	Druckfeder Pressure spring	Unterlegscheibe Washer	Winkelschlüssel Allen key								
<b>TTENN 2020 K 16</b>	20	20	125	10																
<b>2525 M16</b>	25	25	150	12.5									<b>TNM. 16 04..</b>	002001	003001	001002	004003	-	005001	017003
<b>3232 P 16</b>	32	32	170	16																
<b>2525 M22</b>	25	25	150	12.5																
<b>3232 P 22</b>	32	32	170	16									<b>TNM. 22 04..</b>	002002	003002	001004	004002	006001		
<b>4040 S 22</b>	40	40	250	20																

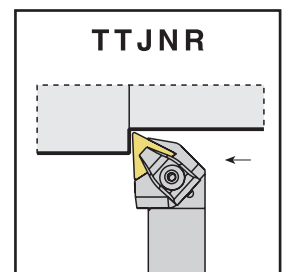
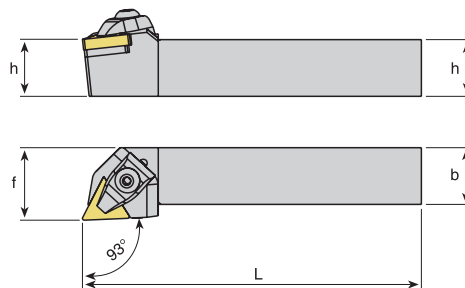

Bezeichnung Designation	Abmessungen (mm) Dimensions (mm)				Wendeplatte Insert	Ersatzteile Spare parts														
	h	b	L	f		Spannpratze (SP) Clamp	Schraube für SP Screw for clamp	Unterlage (UL) Shim	Schraube für UL Screw for shim	Druckfeder Pressure spring	Unterlegscheibe Washer	Winkelschlüssel Allen key								
<b>TTJNR/L 2020 K 16</b>	20	20	125	25																
<b>2525 M16</b>	25	25	150	32									<b>TNM. 16 04..</b>	002001	003001	001002	004003	-	005001	017003
<b>3232 P 16</b>	32	32	170	40																
<b>2525 M22</b>	25	25	150	32																
<b>3232 P 22</b>	32	32	170	40									<b>TNM. 22 04..</b>	002002	003002	001004	004002	006001		
<b>4040 S 22</b>	40	40	250	50																

Bestellbeispiel/Ordering example: 1 Stk./pcs. TTJNR 2020 K16

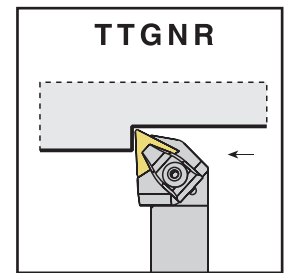
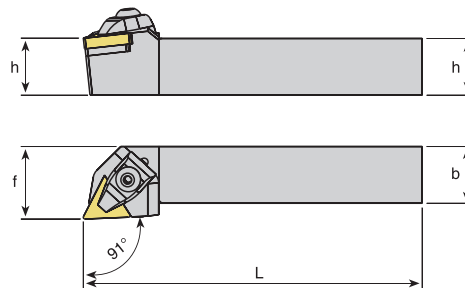
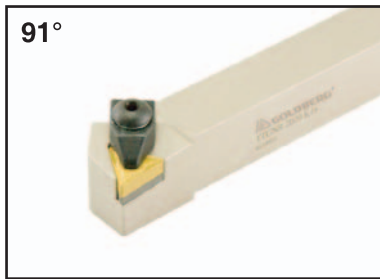

Bezeichnung Designation	Abmessungen (mm) Dimensions (mm)				Wendeplatte Insert	Ersatzteile Spare parts													
	h	b	L	f		Spannpratze (SP) Clamp	Schraube für SP Screw for clamp	Unterlage (UL) Shim	Schraube für UL Screw for shim	Druckfeder Pressure spring	Unterlegscheibe Washer	Winkelschlüssel Allen key							
<b>TTGNR/L 2020 K 16</b>	20	20	125	25															
<b>2525 M 16</b>	25	25	150	32									<b>TNM. 16 04..</b>	002001	003001	001002	004003	-	
<b>3232 P 16</b>	32	32	170	40															
<b>2525 M 22</b>	25	25	150	32															
<b>3232 P 22</b>	32	32	170	40									<b>TNM. 22 04..</b>	002002	003002	001004	004002	006001	
<b>4040 S 22</b>	40	40	250	50															

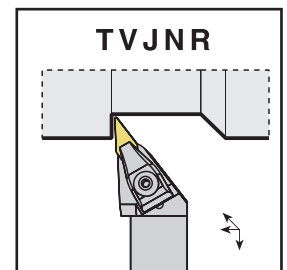
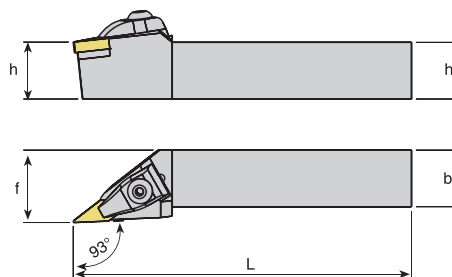

Bezeichnung Designation	Abmessungen (mm) Dimensions (mm)				Wendeplatte Insert	Ersatzteile Spare parts														
	h	b	L	f		Spannpratze (SP) Clamp	Schraube für SP Screw for clamp	Unterlage (UL) Shim	Schraube für UL Screw for shim	Druckfeder Pressure spring	Unterlegscheibe Washer	Winkelschlüssel Allen key								
<b>TVJNR/L 2020 K 16</b>	20	20	125	25																
<b>2525 M 16</b>	25	25	150	32									<b>VNM. 16 04..</b>	002003	003002	001032	004004	006001	005001	017003
<b>3232 P 16</b>	32	32	170	40																

Bestellbeispiel/Ordering example: 1 Stk./pcs. TVJNR 2020 K16

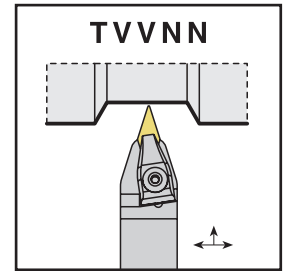
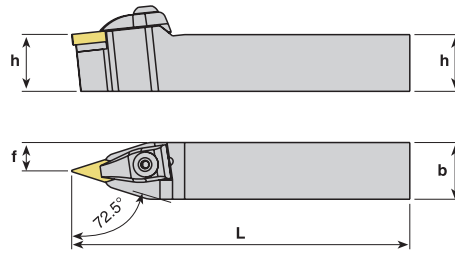

Bezeichnung Designation	Abmessungen (mm) Dimensions (mm)				Wendeplatte Insert	Ersatzteile Spare parts													
	h	b	L	f		Spannpratze (SP) Clamp	Schraube für SP Screw for clamp	Unterlage (UL) Shim	Schraube für UL Screw for shim	Druckfeder Pressure spring	Unterlegscheibe Washer	Winkelschlüssel Allen key							
<b>TVVNN 2020 K 16</b>	20	20	125	10															
<b>2525 M 16</b>	25	25	150	<b>VNM. 16 04..</b>									002003	003002	001032	004004	006001	005001	017003
<b>3232 P 16</b>	32	32	170	16															

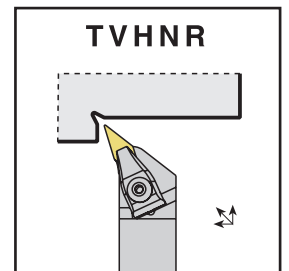
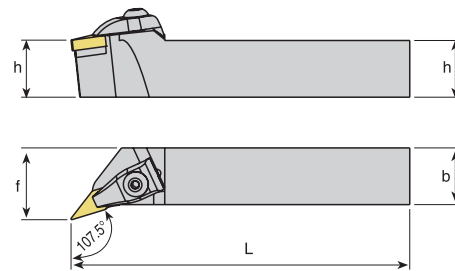

Bezeichnung Designation	Abmessungen (mm) Dimensions (mm)				Wendeplatte Insert	Ersatzteile Spare parts													
	h	b	L	f		Spannpratze (SP) Clamp	Schraube für SP Screw for clamp	Unterlage (UL) Shim	Schraube für UL Screw for shim	Druckfeder Pressure spring	Unterlegscheibe Washer	Winkelschlüssel Allen key							
<b>TVHNR/L 2020 K 16</b>	20	20	125	25															
<b>2525 M 16</b>	25	25	150	<b>VNM. 16 04..</b>									002003	003002	001032	004004	006001	005001	017003
<b>3232 P 16</b>	32	32	170	40															

Bestellbeispiel/Ordering Example: 1 Stk./pcs. TVHNR 2020 K16

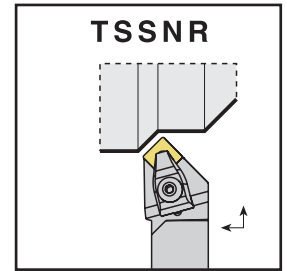
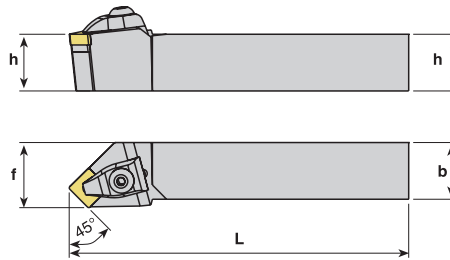

Bezeichnung Designation	Abmessungen (mm) Dimensions (mm)				Wendeplatte Insert	Ersatzteile Spare parts						
	h	b	L	f		Spannpratze (SP) Clamp	Schraube für SP Screw for clamp	Unterlage (UL) Shim	Schraube für UL Screw for shim	Druckfeder Pressure spring	Unterlegscheibe Washer	Winkelschlüssel Allen key
<b>TSSNR/L2020 K 12</b>	20	20	125	25	<b>SNM. 12 04..</b>							
<b>2525 M 12</b>	25	25	150	32								
<b>3232 P 12</b>	32	32	170	40								
<b>2525 M 15</b>	25	25	150	32	<b>SNM. 15 06..</b>					-	-	

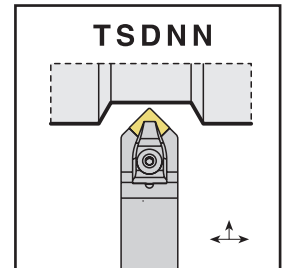
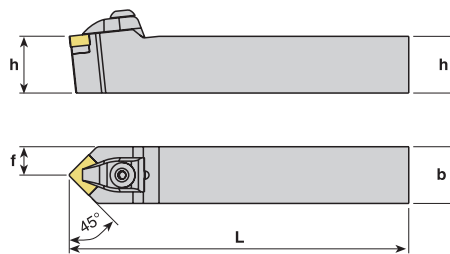

Bezeichnung Designation	Abmessungen (mm) Dimensions (mm)				Wendeplatte Insert	Ersatzteile Spare parts						
	h	b	L	f		Spannpratze (SP) Clamp	Schraube für SP Screw for clamp	Unterlage (UL) Shim	Schraube für UL Screw for shim	Druckfeder Pressure spring	Unterlegscheibe Washer	Winkelschlüssel Allen key
<b>TSDNN 1616 H 12</b>	16	16	100	8	<b>SNM. 12 04..</b>							
<b>2020 K 12</b>	20	20	125	10								
<b>2525 M 12</b>	25	25	150	12.5								
<b>3232 P 12</b>	32	32	170	16								
<b>2525 M 15</b>	25	25	150	12.5	<b>SNM. 15 06..</b>					-	-	
<b>3232 P 15</b>	32	32	170	16								
<b>4040 S 15</b>	40	40	250	20								

Bestellbeispiel/Ordering example: 1 Stk./pcs. TSDNN 1616 H12



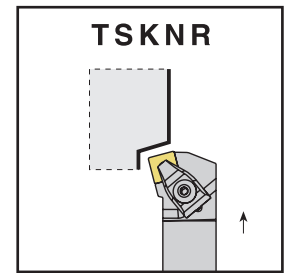
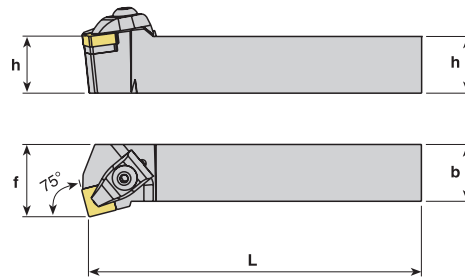

Bezeichnung Designation	Abmessungen (mm) Dimensions (mm)				Wendeplatte Insert	Ersatzteile Spare parts						
	h	b	L	f		Spannpratze (SP) Clamp	Schraube für SP Screw for clamp	Unterlage (UL) Shim	Schraube für UL Screw for shim	Druckfeder Pressure spring	Unterlegscheibe Washer	Winkelschlüssel Allen key
<b>TSKNR/L 2020 K 12</b>	20	20	125	25	<b>SNM. 12 04..</b>							
<b>2525 M12</b>	25	25	150	32								
<b>3232 P 12</b>	32	32	170	40								

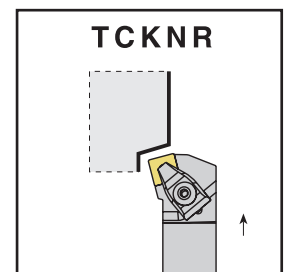
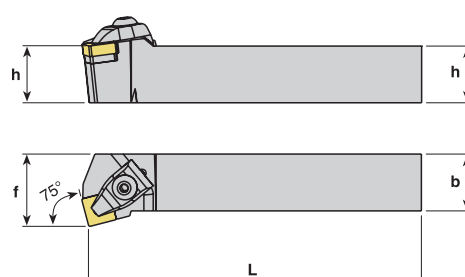

Bezeichnung Designation	Abmessungen (mm) Dimensions (mm)				Wendeplatte Insert	Ersatzteile Spare parts						
	h	b	L	f		Spannpratze (SP) Clamp	Schraube für SP Screw for clamp	Unterlage (UL) Shim	Schraube für UL Screw for shim	Druckfeder Pressure spring	Unterlegscheibe Washer	Winkelschlüssel Allen key
<b>TCKNR/L 2020 K 12</b>	20	20	125	25	<b>CNM. 12 04..</b>							
<b>2525 M12</b>	25	25	150	32								
<b>3232 P 12</b>	32	32	170	40								
<b>2525 M16</b>	25	25	150	32	<b>CNM. 16 06..</b>							
<b>3232 P 16</b>	32	32	170	40								

Bestellbeispiel/Ordering Example: 1 Stk./pcs. TCKNR 2020 K12

# M-System Außendrehhalter / *M-System external toolholders*



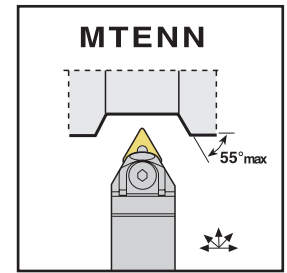
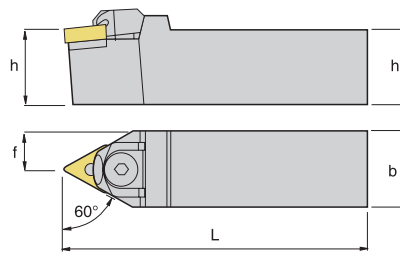
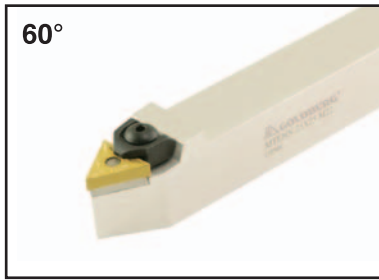

Bezeichnung Designation	Abmessungen (mm) Dimensions (mm)				Wendeplatte Insert	Ersatzteile Spare parts					
	h	b	L	f		Spannsatz (SKS) Wedge clamp	Schraube für SKS Screw for clamp	Unterlage Shim	Stift Pin	Unterlegscheibe Washer	Winkelschlüssel Allen key
<b>MTENN 2020 K 16</b>	20	20	125	10	TNM. 16 04..						
<b>2525 M 16</b>	25	25	150	12.5							
<b>3232 P 16</b>	32	32	170	16							
<b>2525 M 22</b>	25	25	150	12.5	TNM. 22 04..	002008	003002				
<b>3232 P 22</b>	32	32	170	16							
<b>4040 S 22</b>	40	40	250	20							

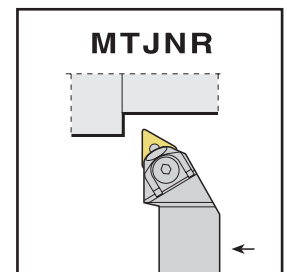
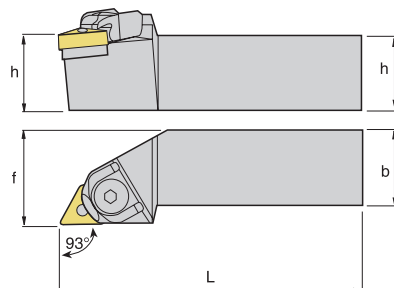

Bezeichnung Designation	Abmessungen (mm) Dimensions (mm)				Wendeplatte Insert	Ersatzteile Spare parts					
	h	b	L	f		Spannsatz (SKS) Wedge clamp	Schraube für SKS Screw for clamp	Unterlage Shim	Stift Pin	Unterlegscheibe Washer	Winkelschlüssel Allen key
<b>MTJNR/L 2020 K 16</b>	20	20	125	25	TNM. 16 04..						
<b>2525 M 16</b>	25	25	150	32							
<b>3232 P 16</b>	32	32	170	40							
<b>2525 M 22</b>	25	25	150	32	TNM. 22 04..	002008	003002				
<b>3232 P 22</b>	32	32	170	40							
<b>4040 S 22</b>	40	40	250	50							

Bestellbeispiel/Ordering Example: 1 Stk/pcs. MTJNR 2020 K16

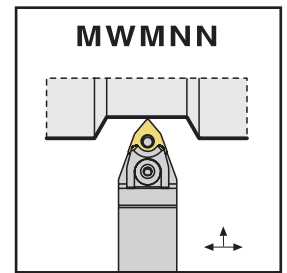
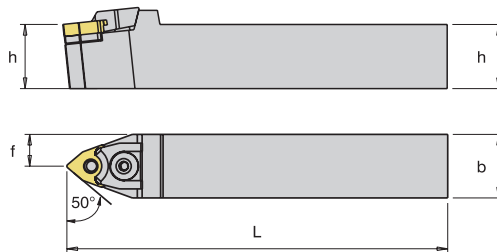
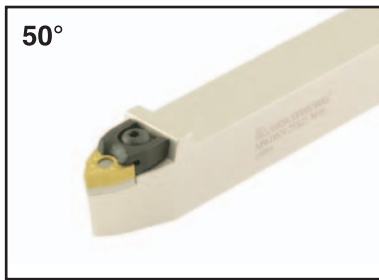

Bezeichnung Designation	Abmessungen (mm) Dimensions (mm)				Wendeplatte Insert	Ersatzteile Spare parts											
	h	b	L	f		Spannkaisatz (SKS) Wedge clamp	Schraube für SKS Screw for clamp	Unterlage Shim	Stift Pin	Unterlegscheibe Washer	Winkelschlüssel Allen key						
<b>MWMNN 1616 H 06-Z</b>	16	16	100	8													
<b>2020 K 06-Z</b>	20	20	125	10								<b>WNM. 06 04..</b>	002005	003004	-	007003	-
<b>2525 M06-Z</b>	25	25	150	12.5													
<b>2020 K 08</b>	20	20	125	10													
<b>2525 M08</b>	25	25	150	12.5								<b>WNM. 08 04..</b>	002009	003003	001017	007002	005001
<b>3232 P 08</b>	32	32	170	16													

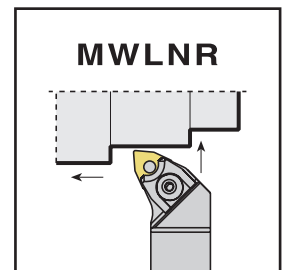
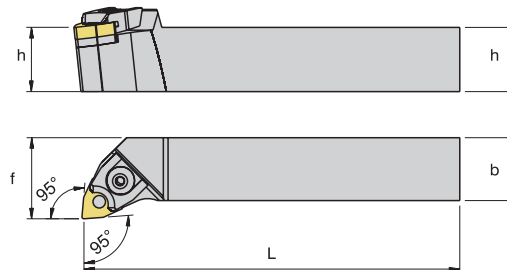

Bezeichnung Designation	Abmessungen (mm) Dimensions (mm)				Wendeplatte Insert	Ersatzteile Spare Parts											
	h	b	L	f		Spannkaisatz (SKS) Wedge clamp	Schraube für SKS Screw for clamp	Unterlage Shim	Stift Pin	Unterlegscheibe Washer	Winkelschlüssel Allen key						
<b>MWLNR/L 1616 H 06-Z</b>	16	16	100	20													
<b>2020 K 06-Z</b>	20	20	125	25								<b>WNM. 06 04..</b>	002005	003004	-	007003	-
<b>2525 M06-Z</b>	25	25	150	32													
<b>2020 K 08</b>	20	20	125	25													
<b>2525 M08</b>	25	25	150	32								<b>WNM. 08 04..</b>	002009	003003	001017	007002	005001
<b>3232 P 08</b>	32	32	170	40													

Bestellbeispiel/Ordering example: 1 Stk/pcs. MWLNR 1616 H06



# S-System Außendrehhalter / *S-System external toolholders*



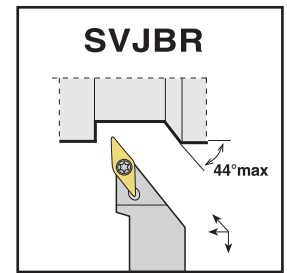
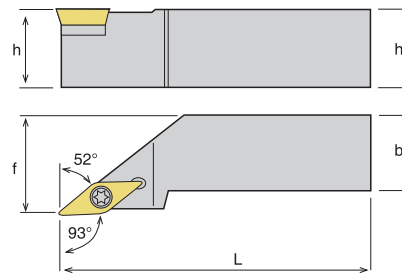

Bezeichnung Designation	Abmessungen (mm) Dimensions (mm)				Wendeplatte Insert	Ersatzteile Spare parts			
	h	b	L	f		Spannschraube für WPL Clamping screw for insert	Unterlage Shim	Schraube für Unterlage Screw for shim	Torx Schlüssel Torx key
<b>SVJBR/L 1212 F 11</b>	12	12	80	16		011007	-	-	018003
<b>1616 H 11</b>	16	16	100	20					
<b>2020 K 11</b>	20	20	125	25					
<b>2020 K 16</b>	20	20	125	25		011042	001032	004006	018005
<b>2525 M 16</b>	25	25	150	32					
<b>3232 P 16</b>	32	32	170	40					

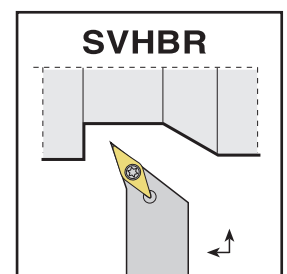
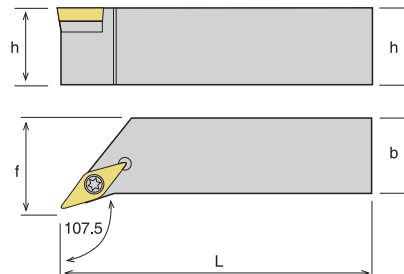

Bezeichnung Designation	Abmessungen (mm) Dimensions (mm)				Wendeplatte Insert	Ersatzteile Spare parts			
	h	b	L	f		Spannschraube für WPL Clamping screw for insert	Unterlage Shim	Schraube für Unterlage Screw for shim	Torx Schlüssel Torx key
<b>SVHBR/L 1212 F 11</b>	12	12	80	16		011007	-	-	018003
<b>1616 H 11</b>	16	16	100	20					
<b>2020 K 11</b>	20	20	125	25					
<b>2020 K 16</b>	20	20	125	25		011042	001032	004006	018005
<b>2525 M 16</b>	25	25	150	32					
<b>3232 P 16</b>	32	32	170	40					

Bestellbeispiel/Ordering example: 1 Stk./pcs. SVHBR 1212.F11

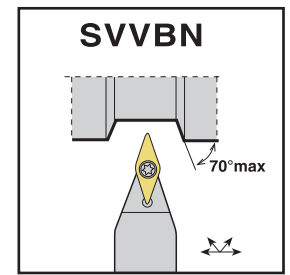
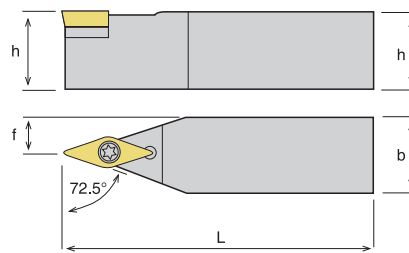

Bezeichnung Designation	Abmessungen (mm) Dimensions (mm)				Wendeplatte Insert	Ersatzteile Spare parts			
	h	b	L	f		Spannschraube für WPL Clamping screw for insert	Unterlage Shim	Schraube für Unterlage Screw for shim	Torx Schlüssel Torx key
<b>SVVBN 1212 F 11</b>	12	12	80	06			-	-	
<b>1616 H 11</b>	16	16	100	08					
<b>2020 K 11</b>	20	20	125	10					
<b>2020 K 16</b>	20	20	125	10			001032	004006	
<b>2525 M 16</b>	25	25	150	12.5					
<b>3232 P 16</b>	32	32	170	16					

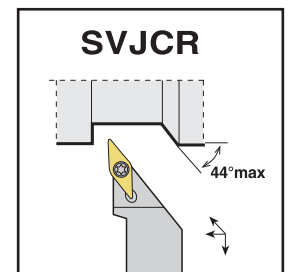
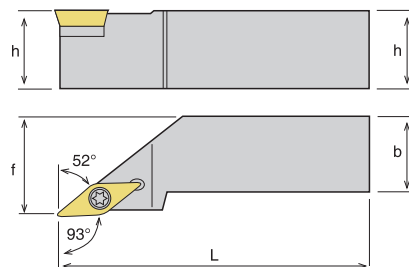

Bezeichnung Designation	Abmessungen (mm) Dimensions (mm)				Wendeplatte Insert	Ersatzteile Spare parts			
	h	b	L	f		Spannschraube für WPL Clamping screw for insert	Unterlage Shim	Schraube für Unterlage Screw for shim	Torx Schlüssel Torx key
<b>SVJCR/L 1212 F 11</b>	12	12	80	16			-	-	
<b>1616 H 11</b>	16	16	100	20					
<b>2020 K 11</b>	20	20	125	25					
<b>2020 K 16</b>	20	20	125	25			001032	004006	
<b>2525 M 16</b>	25	25	150	32					
<b>3232 P 16</b>	32	32	170	40					

Bestellbeispiel/Ordering example: 1 Stk/pcs. SVJCR 1212 F11

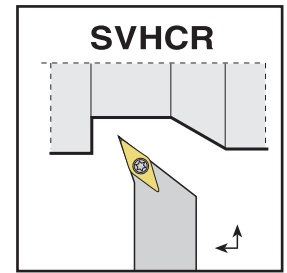
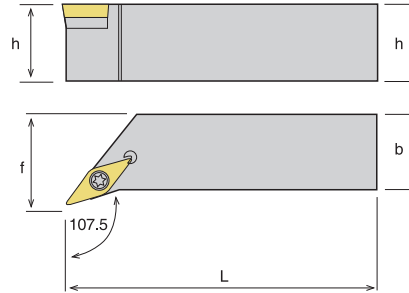

Bezeichnung Designation	Abmessungen (mm) Dimensions (mm)				Wendeplatte Insert	Ersatzteile Spare parts								
	h	b	L	f		Spanschraube für WPL Clamping screw for insert	Unterlage Shim	Schraube für Unterlage Screw for shim	Torx Schlüssel Torx key					
<b>SVHCR/L1212 F 11</b>	12	12	80	16										
<b>1616 H 11</b>	16	16	100	20						<b>VCM. 11 03..</b>	011007	-	-	018003
<b>2020 K 11</b>	20	20	125	25										
<b>2020 K 16</b>	20	20	125	25										
<b>2525 M16</b>	25	25	150	32						<b>VCM. 16 04..</b>	011042	001032	004006	018005
<b>3232 P 16</b>	32	32	170	40										

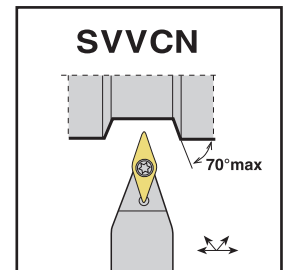
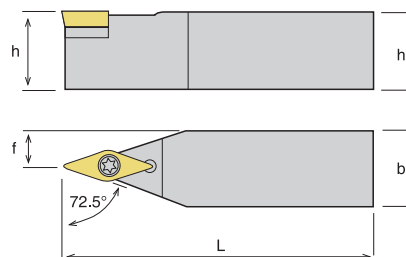

Bezeichnung Designation	Abmessungen (mm) Dimensions (mm)				Wendeplatte Insert	Ersatzteile Spare parts								
	h	b	L	f		Spanschraube für WPL Clamping screw for insert	Unterlage Shim	Schraube für Unterlage Screw for shim	Torx Schlüssel Torx key					
<b>SVVCN 1212 F 11</b>	12	12	80	06										
<b>1616 H 11</b>	16	16	100	08						<b>VCM. 11 03..</b>	011007	-	-	018003
<b>2020 K 11</b>	20	20	125	10										
<b>2020 K 16</b>	20	20	125	10										
<b>2525 M16</b>	25	25	150	12.5						<b>VCM. 16 04..</b>	011042	001032	004006	018005
<b>3232 P 16</b>	32	32	170	16										

Bestellbeispiel/Ordering example: 1 Stk/pcs. SVVCN 1212 F11



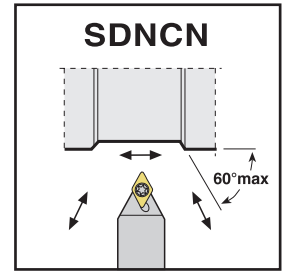
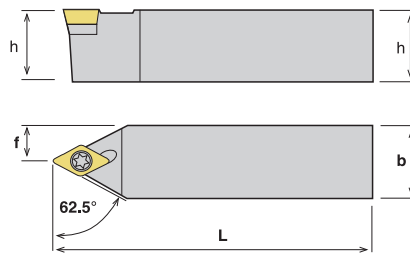



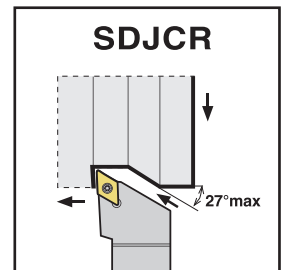
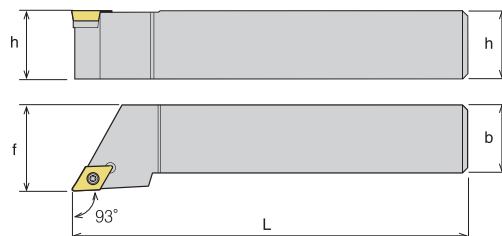

Bezeichnung Designation	Abmessungen (mm) Dimensions (mm)				Wendeplatte Insert	Ersatzteile Spare parts			
	h	b	L	f		Spannschraube für WPL Clamping screw for insert	Unterlage Shim	Schraube für Unterlage Screw for shim	Torx Schlüssel Torx key
<b>SDNCN 0808 E 07</b>	08	08	70	04			-		
<b>1010 E 07</b>	10	10	70	05					
<b>1212 F 07</b>	12	12	80	06					
<b>1616 H 07</b>	16	16	100	08					
<b>1616 H 11</b>	16	16	100	08			001028		
<b>2020 K 11</b>	20	20	125	10					
<b>2525 M 11</b>	25	25	150	12.5					
<b>3232 P 11</b>	32	32	170	16					



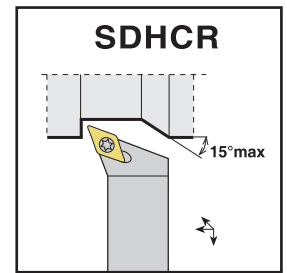
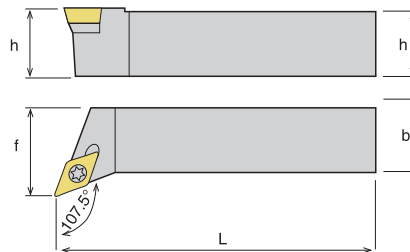

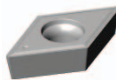

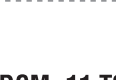
Bezeichnung Designation	Abmessungen (mm) Dimensions (mm)				Wendeplatte Insert	Ersatzteile Spare parts			
	h	b	L	f		Spannschraube für WPL Clamping screw for insert	Unterlage (UL) Shim	Schraube für Unterlage Screw for shim	Torx Schlüssel Torx key
<b>SDJCR/L 0808 E 07</b>	08	08	70	10			-		
<b>1010 E 07</b>	10	10	70	12					
<b>1212 F 07</b>	12	12	80	16					
<b>1616 H 07</b>	16	16	100	20					
<b>1616 H 11</b>	16	16	100	20			001028		
<b>2020 K 11</b>	20	20	125	25					
<b>2525 M 11</b>	25	25	150	32					
<b>3232 P 11</b>	32	32	170	40					

Bestellbeispiel/Ordering Example: 1 Stk/pcs. SDJCR 0808 E07

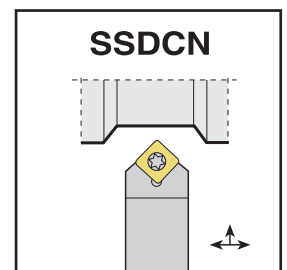
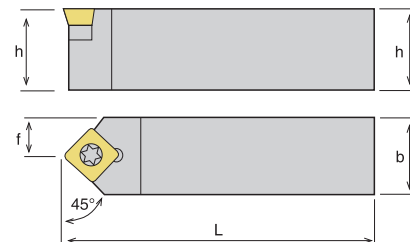
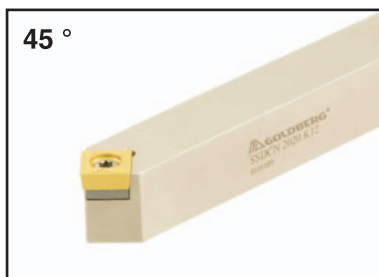

Bezeichnung Designation	Abmessungen (mm) Dimensions (mm)				Wendeplatte Insert	Ersatzteile Spare parts			
	h	b	L	f		Spannschraube für WPL Clamping screw for insert	Unterlage Shim	Schraube für Unterlage Screw for shim	Torx Schlüssel Torx key
<b>SDHCR/L 0808 E 07</b>	08	08	70	10			-	-	
<b>1010 E 07</b>	10	10	70	12					
<b>1212 F 07</b>	12	12	80	16					
<b>1616 H 07</b>	16	16	100	20					
<b>1616 H 11</b>	16	16	100	20			001028	004006	
<b>2020 K 11</b>	20	20	125	25					
<b>2525 M 11</b>	25	25	150	32					
<b>3232 P 11</b>	32	32	170	40					

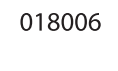

Bezeichnung Designation	Abmessungen (mm) Dimensions (mm)				Wendeplatte Insert	Ersatzteile Spare parts			
	h	b	L	f		Spannschraube für WPL Clamping screw for insert	Unterlage Shim	Schraube für Unterlage Screw for shim	Torx Schlüssel Torx key
<b>SSDCN 1212 F 09</b>	12	12	80	6		011014	-	-	
<b>1616 H 09</b>	16	16	100	8		011042	001021	004006	
<b>2020 K 09</b>	20	20	125	10					
<b>1616 H 12</b>	16	16	100	8		011037	001022	004007	
<b>2020 K 12</b>	20	20	125	10					
<b>2525 M 12</b>	25	25	150	12.5					

Bestellbeispiel/Ordering example: 1 Stk/pcs. SSDCN 1212 F09

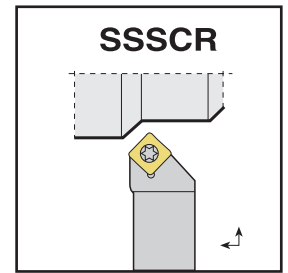
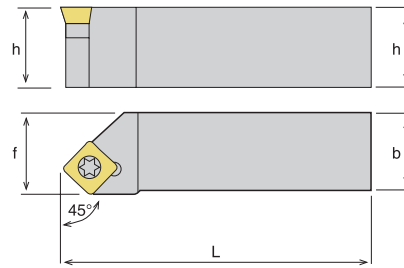

Bezeichnung Designation	Abmessungen (mm) Dimensions (mm)				Wendeplatte Insert	Ersatzteile Spare parts			
	h	b	L	f		Spannschraube für WPL Clamping screw for insert	Unterlage Shim	Schraube für Unterlage Screw for shim	Torx Schlüssel Torx key
<b>SSSCR/L 1212 F 09</b>	12	12	80	16			-	-	
<b>1616 H 09</b>	16	16	100	20		011042	001021	004006	
<b>2020 K 09</b>	20	20	125	25		011042	001021	004006	
<b>1616 H 12</b>	16	16	100	20			-	-	
<b>2020 K 12</b>	20	20	125	25		011037	001022	004007	
<b>2525 M12</b>	25	25	150	32		011037	001022	004007	

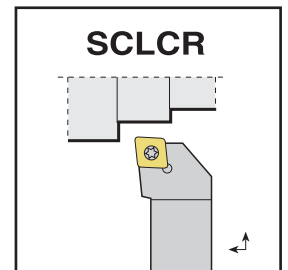
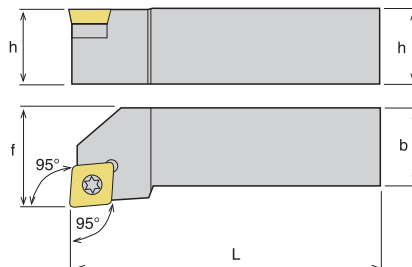
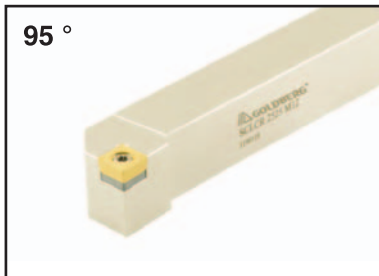

Bezeichnung Designation	Abmessungen (mm) Dimensions (mm)				Wendeplatte Insert	Ersatzteile Spare parts			
	h	b	L	f		Spannschraube für WPL Clamping screw for insert	Unterlage (UL) Shim	Schraube für Unterlage Screw for shim	Torx Schlüssel Torx key
<b>SCLCR/L 0808 E 06</b>	08	08	70	10			-	-	
<b>1010 E 06</b>	10	10	70	12		011007	-	-	
<b>1212 F 09</b>	12	12	80	16		011014	-	-	
<b>1616 H 09</b>	16	16	100	20			001011	004006	
<b>2020 K 09</b>	20	20	125	25		011042	001011	004006	
<b>2020 K 12</b>	20	20	125	25		011042	001011	004006	
<b>2525 M12</b>	25	25	150	32			001012	004007	
						011037	001012	004007	

Bestellbeispiel/Ordering example: 1 Stk/pcs. SCLCR 1616 H06

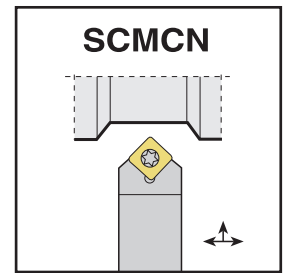
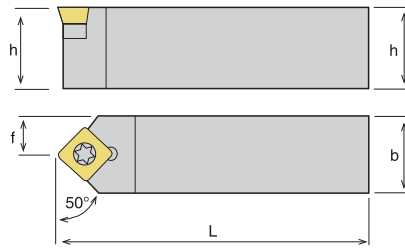

Bezeichnung Designation	Abmessungen (mm) Dimensions (mm)				Wendeplatte Insert	Ersatzteile Spare parts			
	h	b	L	f		Spannschraube für WPL Clamping screw for insert	Unterlage Shim	Schraube für Unterlage Screw for shim	Torx Schlüssel Torx key
<b>SCMCN 0808 E 06</b>	08	08	70	04			-	-	
<b>1010 E 06</b>	10	10	70	05					
<b>1212 F 09</b>	12	12	80	06	<b>CCM. 09 T3..</b>	011014	-	-	018005
<b>1616 H 09</b>	16	16	100	08		011042	001011	004006	
<b>2020 K 12</b>	20	20	125	10	<b>CCM. 12 04..</b>	011037	001012	004007	018006
<b>2525 M12</b>	25	25	150	12,5					

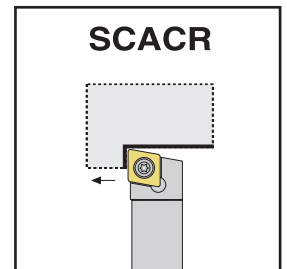
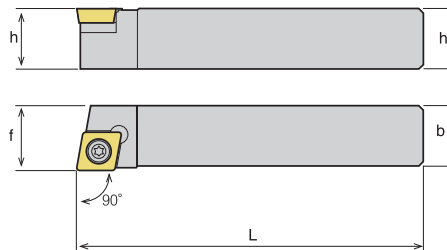

Bezeichnung Designation	Abmessungen (mm) Dimensions (mm)				Wendeplatte Insert	Ersatzteile Spare parts			
	h	b	L	f		Spannschraube für WPL Clamping screw for insert	Unterlage Shim	Schraube für Unterlage Screw for shim	Torx Schlüssel Torx key
<b>SCACR/L 0808 E 06</b>	08	08	70	10			-	-	
<b>1010 E 06</b>	10	10	70	12					
<b>1212 F 09</b>	12	12	80	16	<b>CCM. 09 T3..</b>	011014	-	-	018005
<b>1616 H 09</b>	16	16	100	20		011042	001011	004006	
<b>2020 K 09</b>	20	20	125	25	<b>CCM. 12 04..</b>	011037	001012	004007	018006
<b>2020 K 12</b>	20	20	125	25					
<b>2525 M12</b>	25	25	150	32					

Bestellbeispiel/Ordering example: 1 Stk/pcs. SCACR 0808 E06



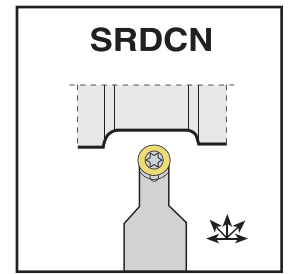
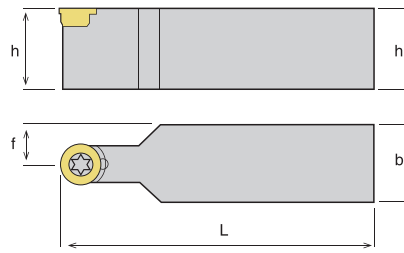

Bezeichnung Designation	Abmessungen (mm) Dimensions (mm)				Wendeplatte Insert	Ersatzteile Spare parts						
	h	b	L	f		Spannschraube Clamping screw	Unterlage (UL) Shim	Schraube für UL Screw for shim	Spannpratze Wedge clamp	Spannschraube Clamping screw	Torx Schlüssel Torx key	
<b>SRDCN 1616 H 06</b>	16	16	100	8		011007	-	-	-	-	018003	
<b>2020 K 06</b>	20	20	125	10								<b>RC.T 06 02..</b>
<b>2525 M06</b>	25	25	150	12.5								
<b>1616 H 08C</b>	16	16	100	8		011043	-	-	-	018005		
<b>2020 K 08C</b>	20	20	125	10							<b>RC.T 08 03..</b>	
<b>2525 M08C</b>	25	25	150	12.5								
<b>1616 H 10C</b>	16	16	100	8		011014	-	-	002022	011014	018005	
<b>2020 K 10C</b>	20	20	125	10					<b>RC.T 10 T3..</b>			
<b>2525 M10C</b>	25	25	150	12.5								
<b>3232 P 10C</b>	32	32	170	16								
<b>2020 K 12C</b>	20	20	125	10		011014	-	-	002014	011032	018006	
<b>2525 M12C</b>	25	25	150	12.5					<b>RC.T 12 04..</b>			
<b>3232 P 12C</b>	32	32	170	16								
<b>3232 P 16C</b>	32	32	170	16	<b>RC.T 16 05..</b>	011040	-	-	-	018006		

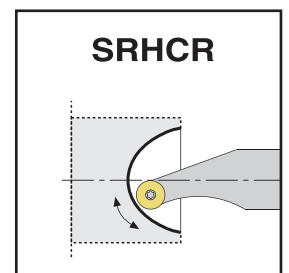
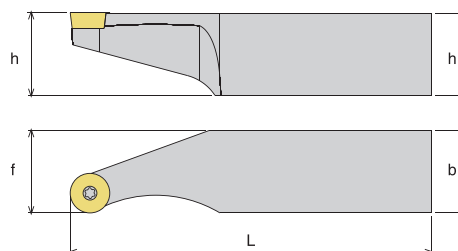

Bezeichnung Designation	Abmessungen (mm) Dimensions (mm)				Wendeplatte Insert	Ersatzteile Spare parts			
	h	b	L	f		Spannschraube Clamping screw	Unterlage (UL) Shim	Schraube für UL Screw for shim	Torx Schlüssel Torx key
<b>SRHCR/L 2525 K10</b>	25	25	125	25	<b>RC.T 10 T3..</b>	011014	-	-	018005
<b>2525 K12</b>	25	25	125	25	<b>RC.T 12 04..</b>				
<b>2525 K16</b>	25	25	125	25	<b>RC.T 16 06..</b>	011040	-	-	018006

Bestellbeispiel/Ordering example: 1 Stk/pcs. SRHCR 2525 K10

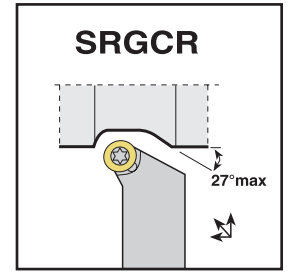
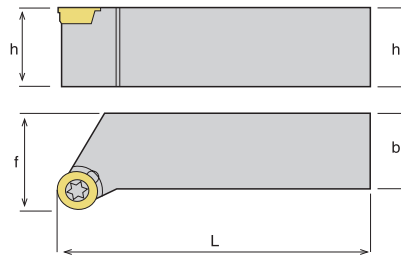

Bezeichnung Designation	Abmessungen (mm) Dimensions (mm)				Wendeplatte Insert	Ersatzteile Spare parts					
	h	b	L	f		Spannschraube Clamping screw	Unterlage (UL) Shim	Schraube für UL Screw for shim	Spannpratze Wedge clamp	Spannschraube Clamping screw	Torx Schlüssel Torx key
<b>SRGCR/L1616 H 06</b>	16	16	100	20			-	-	-	-	018003
<b>2020 K 06</b>	20	20	125	25							
<b>1616 H 08C</b>	16	16	100	20			-	-	002022	011014	018005
<b>2020 K 08C</b>	20	20	125	25							
<b>2525 M08C</b>	25	25	150	32							
<b>1616 H 10C</b>	16	16	100	20			-	-	002014	011032	018005
<b>2020 K 10C</b>	20	20	125	25							
<b>2525 M10C</b>	25	25	150	32							
<b>3232 P 10C</b>	32	32	170	40							
<b>2020 K 12C</b>	20	20	125	25			-	-	002014	011032	018005
<b>2525 M12C</b>	25	25	150	32							
<b>3232 P 12C</b>	32	32	170	40							

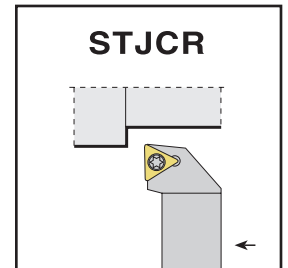
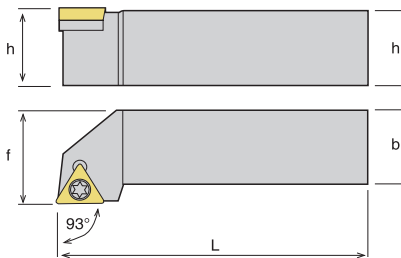

Bezeichnung Designation	Abmessungen (mm) Dimensions (mm)				Wendeplatte Insert	Ersatzteile Spare parts			
	h	b	L	f		Spannschraube Clamping screw	Unterlage (UL) Shim	Schraube für UL Screw for shim	Torx Schlüssel Torx key
<b>STJCR/L 0808 E 09</b>	08	08	70	10			-	-	018002
<b>1010 E 09</b>	10	10	70	12					
<b>1212 F 11</b>	12	12	80	16			-	-	018003
<b>1616 H 11</b>	16	16	100	20					
<b>1616 H 16</b>	16	16	100	20					
<b>2020 K 16</b>	20	20	125	25			001001	004006	018005
<b>2525 M16</b>	25	25	150	32					
<b>3232 P 16</b>	32	32	170	40					

Bestellbeispiel/Ordering example: 1 Stk./pcs. STJCR 0808 E09

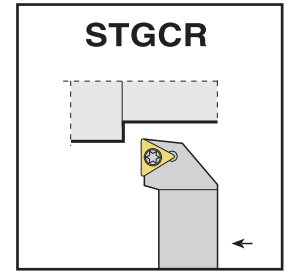
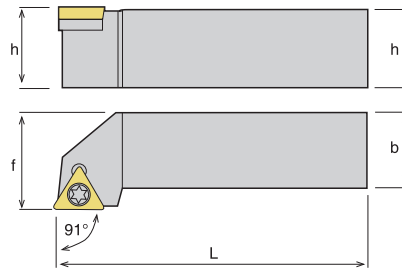
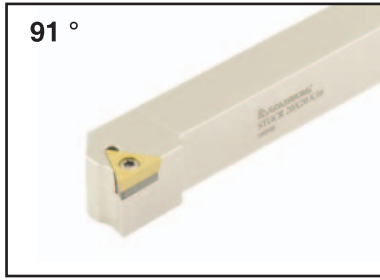



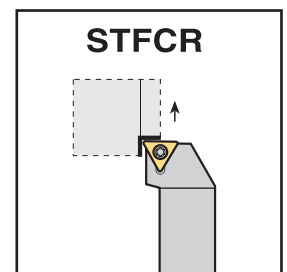
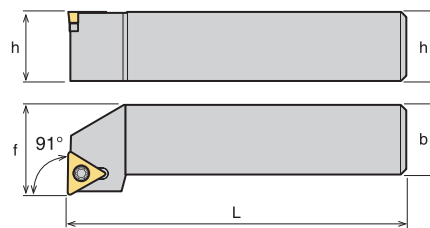



Bezeichnung Designation	Abmessungen (mm) Dimensions (mm)				Wendeplatte Insert	Ersatzteile Spare parts			
	h	b	L	f		Spanschraube Clamping screw	Unterlage (UL) Shim	Schraube für UL Screw for shim	Torx Schlüssel Torx key
<b>STGCR/L 0808 E 09</b>	08	08	70	10					
<b>1010 E 09</b>	10	10	70	12					
<b>1212 F 11</b>	12	12	80	16					
<b>1616 H 11</b>	16	16	100	20	<b>TCM. 11 02..</b>	011007	-	-	018003
<b>1616 H 16</b>	16	16	100	20	<b>TCM. 16 T3..</b>	011042	001001	004006	018005
<b>2020 K 16</b>	20	20	125	25					
<b>2525 M16</b>	25	25	150	32					
<b>3232 P 16</b>	32	32	170	40					

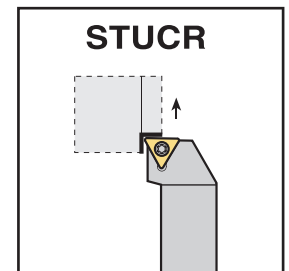
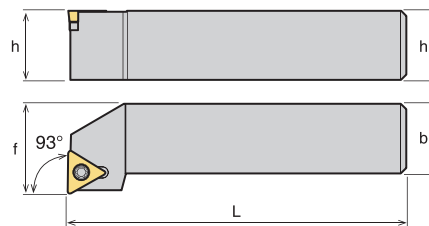

Bezeichnung Designation	Abmessungen (mm) Dimensions (mm)				Wendeplatte Insert	Ersatzteile Spare parts			
	h	b	L	f		Spanschraube Clamping screw	Unterlage (UL) Shim	Schraube für UL Screw for shim	Torx Schlüssel Torx key
<b>STFGR/L 0808 E 09</b>	08	08	70	10					
<b>1010 E 09</b>	10	10	70	12					
<b>1212 F 11</b>	12	12	80	16					
<b>1616 H 11</b>	16	16	100	20	<b>TCM. 11 02..</b>	011007	-	-	018003
<b>1616 H 16</b>	16	16	100	20	<b>TCM. 16 T3..</b>	011042	001001	004006	018005
<b>2020 K 16</b>	20	20	125	25					
<b>2525 M16</b>	25	25	150	32					
<b>3232 P 16</b>	32	32	170	40					

Bestellbeispiel/Ordering example: 1 Stk/pcs. STFGR 0808 E09

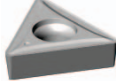

Bezeichnung Designation	Abmessungen (mm) Dimensions (mm)				Wendeplatte Insert	Ersatzteile Spare parts			
	h	b	L	f		Spannschraube Clamping screw	Unterlage (UL) Shim	Schraube für UL Screw for shim	Torx Schlüssel Torx key
									
<b>STUCR/L 0808 E 09</b>	08	08	70	10		011004	-	-	018002
<b>1010 E 09</b>	10	10	70	12					018003
<b>1212 F 11</b>	12	12	80	16		011007	-	-	018005
<b>1616 H 11</b>	16	16	100	20					018005
<b>1616 H 16</b>	16	16	100	20		011042	001001	004006	018005
<b>2020 K 16</b>	20	20	125	25					018005
<b>2525 M16</b>	25	25	150	32					018005
<b>3232 P 16</b>	32	32	170	40					018005

Bestellbeispiel/Ordering example: 1 Stk/pcs. STUCR 0808 E09

# Drehhalter für Langdrehautomaten / *Toolholders for automatic lathes*



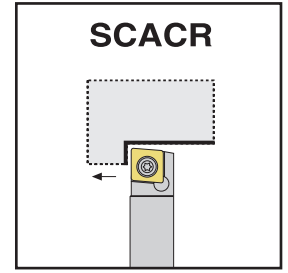
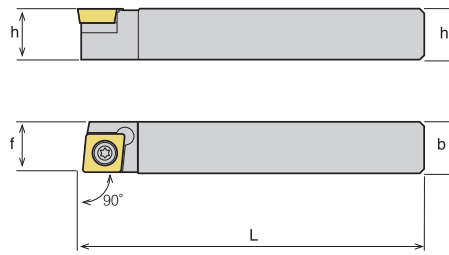
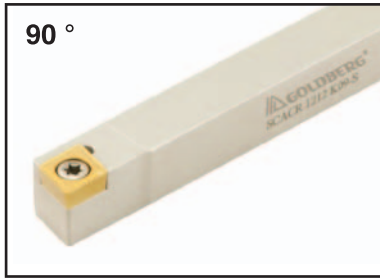

Bezeichnung Designation	Abmessungen (mm) Dimensions (mm)				Wendeplatte Insert	Ersatzteile Spare parts	
	d	h	L	f		Spannschraube Clamping screw	Torx Schlüssel Torx key
<b>SCACR/L 1010 K06-S</b>	10	10	125	10		011007	018003
<b>SCACR/L 1212 K09-S</b>	12	12	125	12		011014	018005
<b>SCACR/L 1616 K09-S</b>	16	16	125	16	<b>CC.T. 09T3..</b>	011042	018006
<b>SCACR/L 2020 K09-S</b>	20	20	125	20		011037	

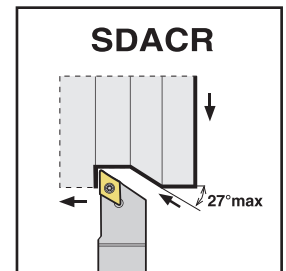
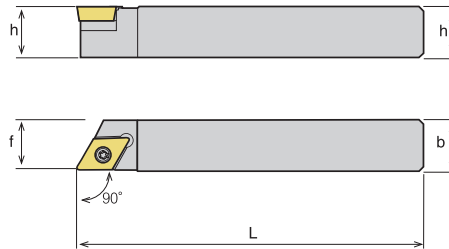

Bezeichnung Designation	Abmessungen (mm) Dimensions (mm)				Wendeplatte Insert	Ersatzteile Spare parts	
	d	h	L	f		Spannschraube Clamping screw	Torx Schlüssel Torx key
<b>SDACR/L 1010 K07-S</b>	10	10	125	10		011007	018003
<b>SDACR/L 1212 K07-S</b>	12	12	125	12			
<b>SDACR/L 1616 K07-S</b>	16	16	125	16			
<b>SDACR/L 1212 K11-S</b>	12	12	125	12	<b>DC.T. 11T3..</b>	011042	018005
<b>SDACR/L 1616 K11-S</b>	16	16	125	16			
<b>SDACR/L 2020 K11-S</b>	20	20	125	20			

Bestellbeispiel/Ordering example: 1 Stk/pcs. SDACR 1010 K07 S



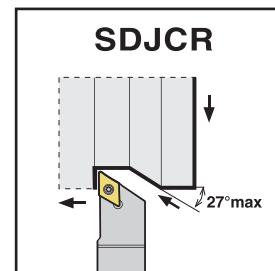
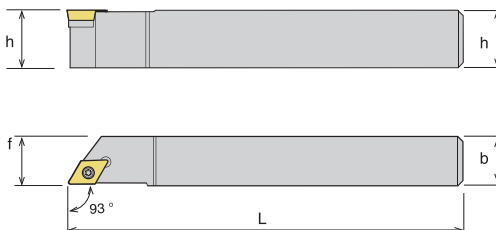

Bezeichnung Designation	Abmessungen (mm) Dimensions (mm)				Wendeplatte Insert	Ersatzteile Spare parts	
	d	h	L	f		Spannschraube Clamping screw	Torx Schlüssel Torx key
SDJCR/L 1212 K11-S	12	12	125	12			
SDJCR/L 1616 K11-S	16	16	125	16			

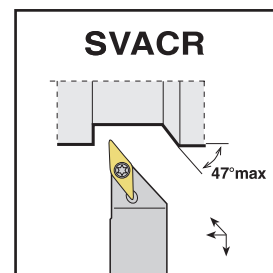
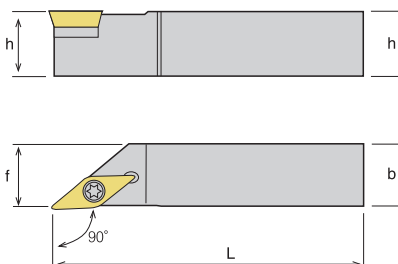

Bezeichnung Designation	Abmessungen (mm) Dimensions (mm)				Wendeplatte Insert	Ersatzteile Spare parts				
	d	h	L	f		Spannschraube Clamping screw	Torx Schlüssel Torx key			
SVACR/L 1212 K11-S	12	12	125	12						
SVACR/L 1616 K11-S	16	16	125	16				VC.T 1103..	011007	018003
SVACR/L 2020 K11-S	20	20	125	20						

Bestellbeispiel/Ordering example: 1 Stk/pcs. SVACR 1212 K11 S

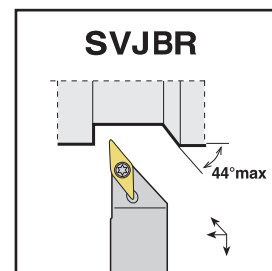
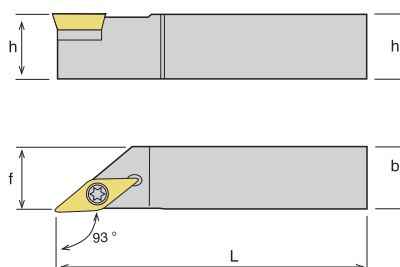

Bezeichnung Designation	Abmessungen (mm) Dimensions (mm)				Wendeplatte Insert	Ersatzteile Spare parts	
	d	h	L	f		Spannschraube Clamping screw	Torx Schlüssel Torx key
<b>SVJBR/L 1616 K11-S</b>	16	16	125	16	 <b>VBM. 1103..</b>	 011007	 018003

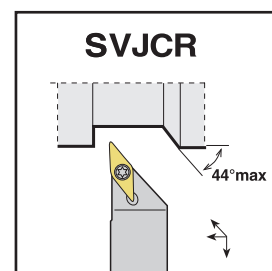
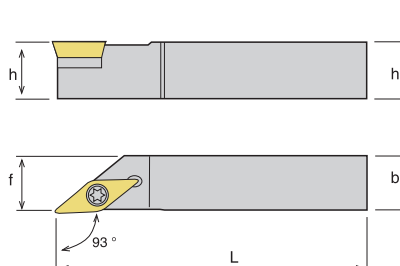

Bezeichnung Designation	Abmessungen (mm) Dimensions (mm)				Wendeplatte Insert	Ersatzteile Spare parts	
	d	h	L	f		Spannschraube Clamping screw	Torx Schlüssel Torx key
<b>SVJCR/L 1212 K11-S</b>	12	12	125	12	 <b>VC.T 1103..</b>	 011007	 018003

Bestellbeispiel/Ordering example: 1 Stk/pcs. SVJCR 1212 K11 S

# P-System Außendrehhalter / *P-System external toolholders*



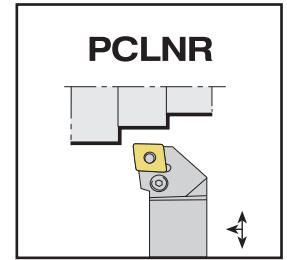
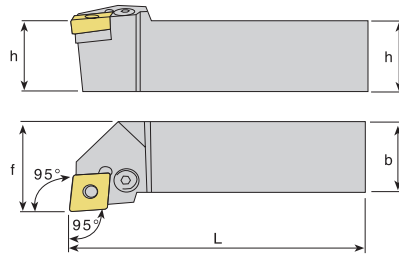
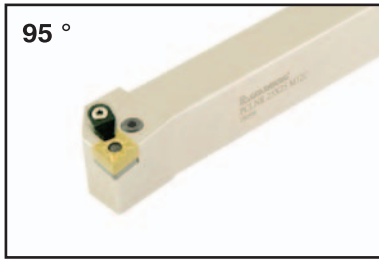

Bezeichnung Designation	Abmessungen (mm) Dimensions (mm)				Wendeplatte Insert	Ersatzteile Spare parts						
	h	b	L	f		Hebel (H) Lever	Schraube für H Screw for lever	Unterlage (UL) Shim	Druckfeder für UL Pressure spring	Spannpratze Wedge clamp	Spannschraube Clamping screw	Winkelschlüssel Allen key
<b>PCLNR/L 1616 H 09</b>	16	16	100	20	<b>CNM. 09 03..</b>	008008	009008	001034	010006	-	-	017002
<b>2020 K 09</b>	20	20	125	25								
<b>2525 M 09</b>	25	25	150	32								
<b>1616 H 12C</b>	16	16	100	20	<b>CNM. 12 04..</b>	008002	009003	001013	010002	002014	011032	017003
<b>2020 K 12C</b>	20	20	125	25								
<b>2525 M 12C</b>	25	25	150	32								
<b>3232 P 12C</b>	32	32	170	40	<b>CNM. 16 06..</b>	008004	009004	001014	010003	002018	003010	017004
<b>2525 M 16C</b>	25	25	150	32								
<b>3232 P 16C</b>	32	32	170	40								
<b>2525 M 19C</b>	25	25	150	32	<b>CNM. 19 06..</b>	008005	009005	001015	010004	002013	003015	017005
<b>3232 P 19C</b>	32	32	170	40								
<b>4040 S 19C</b>	40	40	250	50								
<b>4040 S 25C</b>	40	40	250	50	<b>CNM. 25 09..</b>	008006	009006	001016	010005	002013	003015	017005
<b>5050 S 25C</b>	50	50	250	60								

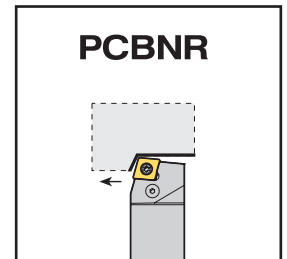
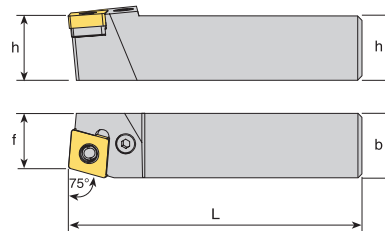

Bezeichnung Designation	Abmessungen (mm) Dimensions (mm)				Wendeplatte Insert	Ersatzteile Spare parts						
	h	b	L	f		Hebel (H) Lever	Schraube für H Screw for lever	Unterlage (UL) Shim	Druckfeder für UL Pressure spring	Spannpratze Wedge clamp	Spannschraube Clamping screw	Winkelschlüssel Allen key
<b>PCBNR/L 2020 K 12C</b>	20	20	125	25	<b>CNM. 12 04..</b>	008002	009003	001013	010002	002014	011032	017003
<b>2525 M 12C</b>	25	25	150	32								
<b>3232 P 12C</b>	32	32	170	40								
<b>2525 M 16C</b>	25	25	150	32	<b>CNM. 16 06..</b>	008004	009004	001014	010003	002018	003010	017004
<b>3232 P 16C</b>	32	32	170	40								
<b>3232 P 19C</b>	32	32	170	40								
<b>4040 S 19C</b>	40	40	250	50	<b>CNM. 19 06..</b>	008005	009005	001015	010004	002013	003015	017005
<b>4040 S 25C</b>	40	40	250	50								
<b>5050 S 25C</b>	50	50	250	60								

Bestellbeispiel/Ordering example: 1 Stk/pcs. PCBNR 2020 K12C

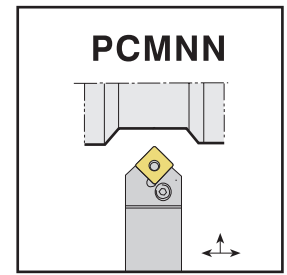
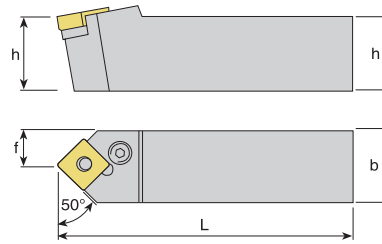
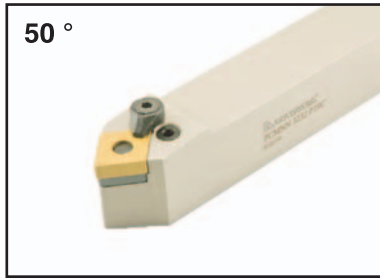

Bezeichnung Designation	Abmessungen (mm) Dimensions (mm)				Wendeplatte Insert	Ersatzteile Spare parts														
	h	b	L	f		Hebel (H) Lever	Schraube für H Screw for lever	Unterlage (UL) Shim	Druckfeder für UL Pressure spring	Spannpratze Wedge clamp	Spannschraube Clamping screw	Winkelschlüssel Allen key								
<b>PCMNN 2020 K 12C</b>	20	20	125	10																
<b>2525 M 12C</b>	25	25	150	12.5									<b>CNM. 12 04..</b>	008002	009003	001023	010002	002014	011032	017003
<b>3232 P 12C</b>	32	32	170	16																
<b>2525 M 16C</b>	25	25	150	12.5																
<b>3232 P 16C</b>	32	32	170	16									<b>CNM. 16 06..</b>	008004	009004	001024	010003			
<b>3232 P 19C</b>	32	32	170	16														002018	003010	017004
<b>4040 S 19C</b>	40	40	250	20																
<b>5050 S 19C</b>	50	50	250	25									<b>CNM. 19 06..</b>	008005	009005	001025	010004			

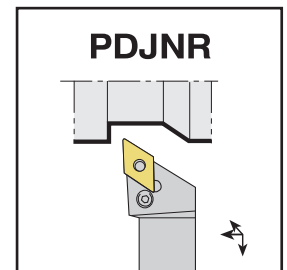
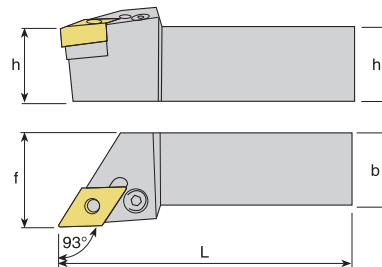

Bezeichnung Designation	Abmessungen (mm) Dimensions (mm)				Wendeplatte Insert	Ersatzteile Spare parts														
	h	b	L	f		Hebel (H) Lever	Schraube für H Screw for lever	Unterlage (UL) Shim	Druckfeder für UL Pressure spring	Spannpratze Wedge clamp	Spannschraube Clamping screw	Winkelschlüssel Allen key								
<b>PDJNR/L 1616 H 11</b>	16	16	100	20																
<b>2020 K 11</b>	20	20	125	25									<b>DNM. 11 04..</b>	008001	009002	001029	010001	-	-	017002
<b>2525 M 11</b>	25	25	150	32																
<b>2020 K 15C</b>	20	20	125	25																
<b>2525 M 15C</b>	25	25	150	32									<b>DNM. 15 06..</b>	008003	009003	001030	010002	002014	011032	017003
<b>3232 P 15C</b>	32	32	170	40																

Bestellbeispiel/Ordering Example: 1 Stk/pcs. PDJNR 1616 H11

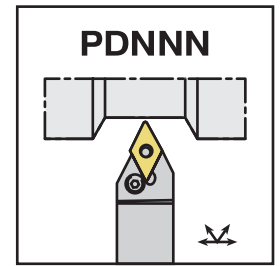
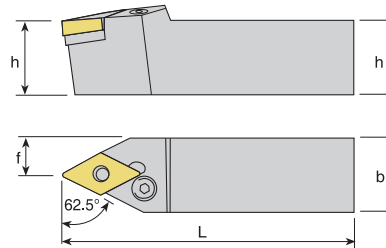
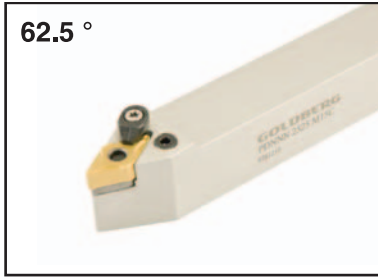

Bezeichnung Designation	Abmessungen (mm) Dimensions (mm)				Wendeplatte Insert	Ersatzteile Spare parts							
	h	b	L	f		Hebel (H) Lever	Schraube für H Screw for lever	Unterlage (UL) Shim	Druckfeder für UL Pressure spring	Spannpratze Wedge clamp	Spannschraube Clamping screw	Winkelschlüssel Allen key	
<b>PDNN 1616 H 11</b>	16	16	100	8						-	-	017002	
<b>2020 K 11</b>	20	20	125	10									<b>DNM. 11 04..</b>
<b>2525 M 11</b>	25	25	150	12,5									
<b>2020 K 15C</b>	20	20	125	10						002014	011032	017003	
<b>2525 M 15C</b>	25	25	150	12,5									<b>DNM. 15 06..</b>
<b>3232 P 15C</b>	32	32	170	16									

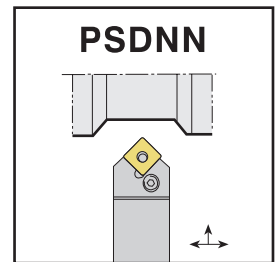
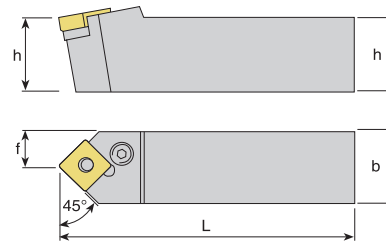

Bezeichnung Designation	Abmessungen (mm) Dimensions (mm)				Wendeplatte Insert	Ersatzteile Spare parts							
	h	b	L	f		Hebel (H) Lever	Schraube für H Screw for lever	Unterlage (UL) Shim	Druckfeder für UL Pressure spring	Spannpratze Wedge clamp	Spannschraube Clamping screw	Winkelschlüssel Allen key	
<b>PSDNN 1616 H 09</b>	16	16	100	8						-	-	017002	
<b>2020 K 12C</b>	20	20	125	10									<b>SNM. 09 03..</b>
<b>2525 M12C</b>	25	25	150	12,5									<b>SNM. 12 04..</b>
<b>3232 P 12C</b>	32	32	170	16						002014	011032	017003	
<b>2020 K 15C</b>	20	20	125	10									<b>SNM. 12 04..</b>
<b>2525 M15C</b>	25	25	150	12,5									<b>SNM. 15 06..</b>
<b>3232 P 19C</b>	32	32	170	16						002018	003010	017004	
<b>2020 K 15C</b>	20	20	125	10									<b>SNM. 15 06..</b>
<b>2525 M15C</b>	25	25	150	12,5									<b>SNM. 19 06..</b>
<b>4040 S 19C</b>	40	40	250	20						002013	003015	017005	
<b>5050 S 19C</b>	50	50	250	25									<b>SNM. 19 06..</b>
<b>4040 S 25C</b>	40	40	250	20									<b>SNM. 25 07..</b>
<b>5050 S 25C</b>	50	50	250	25									

Bestellbeispiel/Ordering example: 1 Stk/pcs. PSDNN 1616 H09



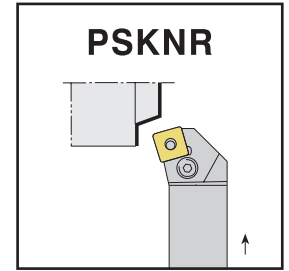
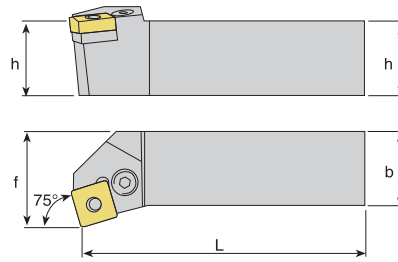
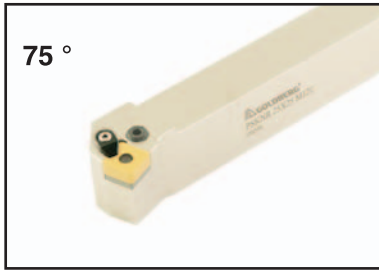

Bezeichnung Designation	Abmessungen (mm) Dimensions (mm)				Wendeplatte Insert	Ersatzteile Spare parts						
	h	b	L	f		Hebel (H) Lever	Schraube für H Screw for lever	Unterlage (UL) Shim	Druckfeder für UL Pressure spring	Spannpratze Wedge clamp	Spannschraube Clamping screw	Winkelschlüssel Allen key
<b>PSKNR/L 2020 K 09</b>	20	20	125	25	<b>SNM. 09 03..</b>	008009	009009	001035	010007	-	-	017002
<b>2020 K 12C</b>	20	20	125	25	<b>SNM. 12 04..</b>	008002	009003	001023	010002	002014	011032	017003
<b>2525 M 12C</b>	25	25	150	32								
<b>3232 P 12C</b>	32	32	170	40								
<b>2525 M 15C</b>	25	25	150	32	<b>SNM. 15 06..</b>	008004	009004	001024	010003	002018	003010	017004
<b>3232 P 15C</b>	32	32	170	40								
<b>3232 P 19C</b>	32	32	170	40	<b>SNM. 19 06..</b>	008005	009005	001025	010004	002013	003015	017005
<b>4040 S 19C</b>	40	40	250	50								
<b>4040 S 25C</b>	40	40	250	50	<b>SNM. 25 07..</b>	008006	009006	001026	010005	002013	003015	017005
<b>5050 S 25C</b>	50	50	250	60								

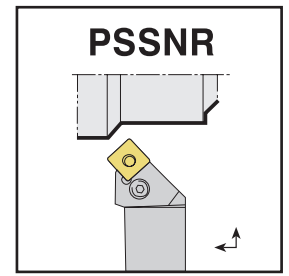
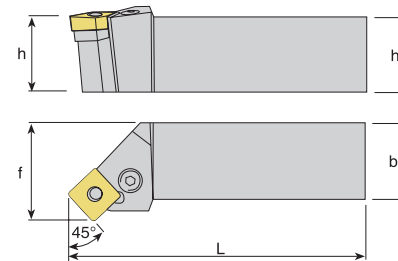

Bezeichnung Designation	Abmessungen (mm) Dimensions (mm)				Wendeplatte Insert	Ersatzteile Spare parts						
	h	b	L	f		Hebel (H) Lever	Schraube für H Screw for lever	Unterlage (UL) Shim	Druckfeder für UL Pressure spring	Spannpratze Wedge clamp	Spannschraube Clamping screw	Winkelschlüssel Allen key
<b>PSSNR/L 1616 H 09</b>	16	16	100	20	<b>SNM. 09 03..</b>	008009	009009	001035	010007	-	-	017002
<b>2020 K 09</b>	20	20	125	25								
<b>2020 K 12C</b>	20	20	125	25	<b>SNM. 12 04..</b>	008002	009003	001023	010002	002014	011032	017003
<b>2525 M 12C</b>	25	25	150	32								
<b>3232 P 12C</b>	32	32	170	40								
<b>3232 P 15C</b>	32	32	170	40	<b>SNM. 15 06..</b>	008004	009004	001024	010003	002018	003010	017004
<b>3232 P 19C</b>	32	32	170	40								
<b>4040 S 19C</b>	40	40	250	50	<b>SNM. 19 06..</b>	008005	009005	001025	010004	002013	003015	017005
<b>4040 S 25C</b>	40	40	250	50								

Bestellbeispiel/Ordering example: 1 Stk/pcs. PSSNR 1616 H09

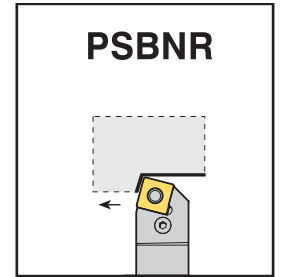
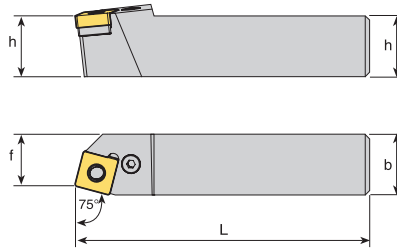
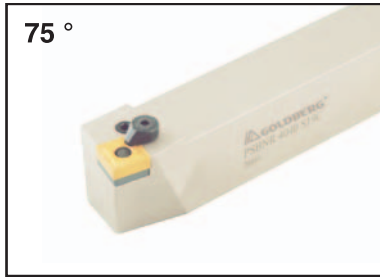

Bezeichnung Designation	Abmessungen (mm) Dimensions (mm)				Wendeplatte Insert	Ersatzteile Spare parts						
	h	b	L	f		Hebel (H) Lever	Schraube für H Screw for lever	Unterlage (UL) Shim	Druckfeder für UL Pressure spring	Spannpratze Wedge clamp	Spannschraube Clamping screw	Winkelschlüssel Allen key
<b>PSBNR/L 1616 H 09</b>	16	16	100	20						-	-	017002
<b>2020 K 09</b>	20	20	125	25								
<b>2020 K 12C</b>	20	20	125	25						002014	011032	017003
<b>2525 M 12C</b>	25	25	150	32								
<b>3232 P 12C</b>	32	32	170	40								
<b>2525 M 15C</b>	25	25	150	32						-	-	-
<b>3232 P 19C</b>	32	32	170	40								
<b>4040 S 19C</b>	40	40	250	50						002018	003010	017004
<b>4040 S 25C</b>	40	40	250	50								
<b>5050 S 25C</b>	50	50	250	63						002013	003015	017005

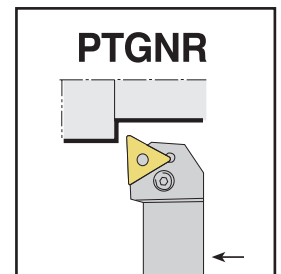
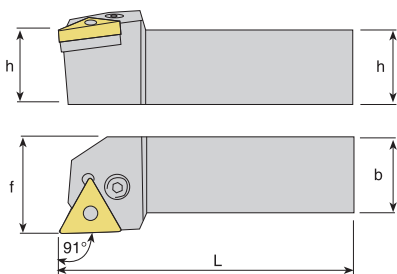

Bezeichnung Designation	Abmessungen (mm) Dimensions (mm)				Wendeplatte Insert	Ersatzteile Spare parts						
	h	b	L	f		Hebel (H) Lever	Schraube für H Screw for lever	Unterlage (UL) Shim	Druckfeder für UL Pressure spring	Spannpratze Wedge clamp	Spannschraube Clamping screw	Winkelschlüssel Allen key
<b>PTGNR/L 1010 E 11</b>	10	10	70	12				-	-	-	-	-
<b>1212 F 11</b>	12	12	80	16								
<b>1616 H 11</b>	16	16	100	20								
<b>1616 H 16</b>	16	16	100	20						-	-	017002
<b>2020 K 16</b>	20	20	125	25								
<b>2525 M 16</b>	25	25	150	32								
<b>3232 P 16</b>	32	32	170	40								
<b>2525 M 22C</b>	25	25	150	32						002014	011032	017003
<b>3232 P 22C</b>	32	32	170	40								
<b>4040 S 27</b>	40	40	250	50						-	-	017004

Bestellbeispiel/Ordering example: 1 Stk/pcs. PTGNR 1010 E11

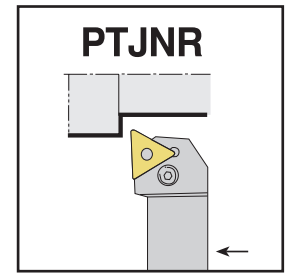
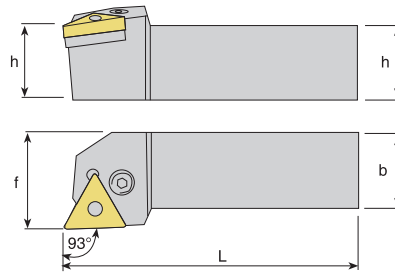
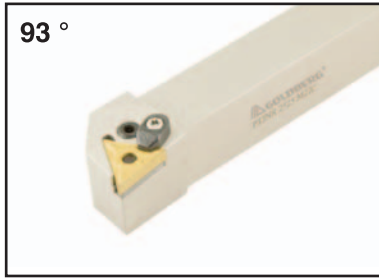

Bezeichnung Designation	Abmessungen (mm) Dimensions (mm)				Wendeplatte Insert	Ersatzteile Spare parts						
	h	b	L	f		Hebel (H) Lever	Schraube für H Screw for lever	Unterlage (UL) Shim	Druckfeder für UL Pressure spring	Spannpratze Wedge clamp	Spannschraube Clamping screw	Winkelschlüssel Allen key
<b>PTJNR/L 1010 E 11</b>	10	10	70	12	<b>TNM. 11 03..</b>	008010	009010	-	-	-	-	017002
<b>1212 F 11</b>	12	12	80	16								
<b>1616 H 11</b>	16	16	100	20								
<b>1616 H 16</b>	16	16	100	20	<b>TNM. 16 04..</b>	008001	009002	001003	010001	-	-	017002
<b>2020 K 16</b>	20	20	125	25								
<b>2525 M16</b>	25	25	150	32								
<b>3232 P 16</b>	32	32	170	40								
<b>2525 M22C</b>	25	25	150	32	<b>TNM. 22 04..</b>	008002	009003	001004	010002	002014	011032	017003
<b>3232 P 22C</b>	32	32	170	40								
<b>4040 S 27</b>	40	40	250	50	<b>TNM. 27 06..</b>	008011	009011	001036	010008	-	-	017004

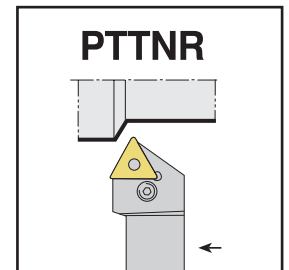
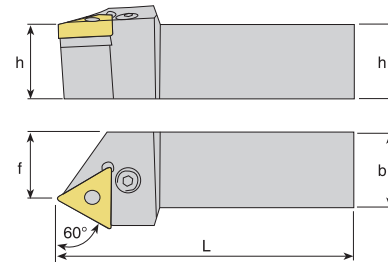

Bezeichnung Designation	Abmessungen (mm) Dimensions (mm)				Wendeplatte Insert	Ersatzteile Spare parts						
	h	b	L	f		Hebel (H) Lever	Schraube für H Screw for lever	Unterlage (UL) Shim	Druckfeder für UL Pressure spring	Spannpratze Wedge clamp	Spannschraube Clamping screw	Winkelschlüssel Allen key
<b>PTTNR/L1616 H 16</b>	16	16	100	13	<b>TNM. 16 04..</b>	008001	009002	001003	010001	-	-	017002
<b>2020 K 16</b>	20	20	125	17								
<b>2525 M16</b>	25	25	150	21,5								
<b>3232 P 16</b>	32	32	170	31								
<b>2525 M22C</b>	25	25	150	20,5	<b>TNM. 22 04..</b>	008002	009003	001004	010002	002014	011032	017003
<b>3232 P 22C</b>	32	32	170	29								

Bestellbeispiel/Ordering example: 1 Stk/pcs. PTTNR 1616 H16

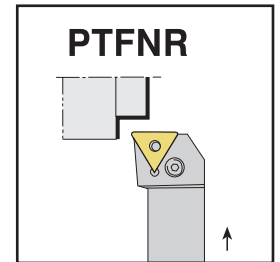
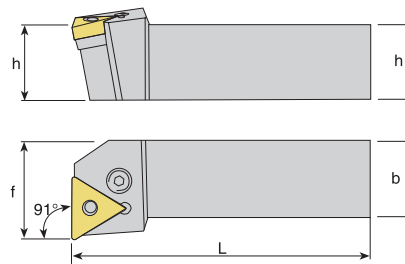
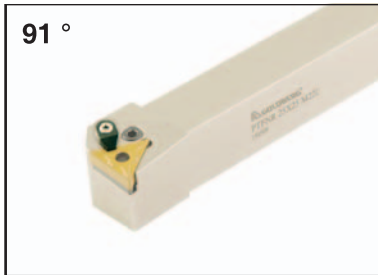

Bezeichnung Designation	Abmessungen (mm) Dimensions (mm)				Wendeplatte Insert	Ersatzteile Spare parts														
	h	b	L	f		Hebel (H) Lever	Schraube für H Screw for lever	Unterlage (UL) Shim	Druckfeder für UL Pressure spring	Spannpratze Wedge clamp	Spannschraube Clamping screw	Winkelschlüssel Allen key								
<b>PTFNR/L 1616 H 16</b>	16	16	100	20																
<b>2020 K 16</b>	20	20	125	25									TNM. 16 04..	008001	009002	001003	010001	-	-	017002
<b>2525 M 16</b>	25	25	150	32																
<b>3232 P 16</b>	32	32	170	40																
<b>2525 M 22C</b>	25	25	150	32	TNM. 22 04..	008002	009003	001004	010002	002014	011032	017003								
<b>3232 P 22C</b>	32	32	170	40																
<b>4040 S 27</b>	40	40	250	50	TNM. 27 06..	008011	009011	001036	010008	-	-	017004								

Bestellbeispiel/Ordering example: 1 Stk/pcs. PWFNR 1616 H06

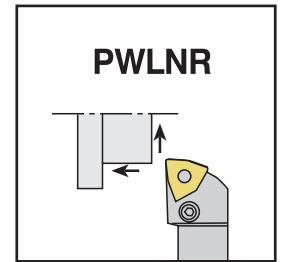
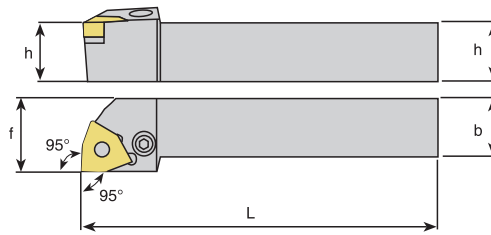
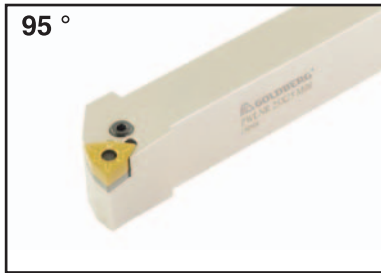

Bezeichnung Designation	Abmessungen (mm) Dimensions (mm)				Wendeplatte Insert	Ersatzteile Spare parts						
	h	b	L	f		Hebel (H) Lever	Schraube für H Screw for lever	Unterlage (UL) Shim	Druckfeder für UL Pressure spring	Spannpratze Wedge clamp	Spannschraube Clamping screw	Winkelschlüssel Allen key
<b>PWLNR/L 1616 H 06</b>	16	16	100	20	<b>WNM. 06 04..</b> 							
<b>2020 K 06</b>	20	20	125	25								
<b>2525 M 06</b>	25	25	150	32								
<b>3232 P 06</b>	32	32	170	40								
<b>1616 H 08</b>	16	16	100	20	<b>WNM. 08 04..</b> 							
<b>2020 K 08C</b>	20	20	125	25								
<b>2525 M 08C</b>	25	25	150	32								
<b>3232 P 08C</b>	32	32	170	40								

Bestellbeispiel/Ordering example: 1 Stk/pcs. PWLNR 1616 H06



**1** Grundform der Wendschneidplatte / Basic shape of indexable insert

A: Vollstahlausführung mit innere Kühlmittelzufuhr / Solid steel design with internal coolant supply  
E: Hartmetallschaft mit Kopf aus Stahl und innere Kühlmittelzufuhr / Carbide shank with steel head and supply internal coolant  
C: Hartmetallschaft mit Kopf aus Stahl ohne innere Kühlmittelzufuhr / Carbide shank with steel head and without internal coolant supply  
S: Vollstahlausführung ohne innere Kühlmittelzufuhr / Solid steel design without internal coolant supply

**2** Bohrstangendurchmesser (mm)  
Boring bar diameter (mm)

**3** Drehhalterlänge (mm) / Turning toolholder length (mm)

**4** Art der Schneidplattenbefestigung / Type of insert mounting

C T M P S

A-32	H-100	Q-180	x-special (mm)
B-40	J-110	R-200	
C-50	K-125	S-250	
D-60	L-140	T-300	
E-70	M-150	U-350	
F-80	N-160	V-400	
G-90	P-170	W-450	

**5** Grundform der Wendschneidplatte / Basic shape of indexable insert

C	D	E
V	R	S
W	K	T

**6** Anstellwinkel / Approach angle

**7** Freiwinkel der Wendschneidplatte / Indexable insert clearance angle

**8** Drehhalterauführung / Turning toolholder version

**9** Länge der Schneidkante (mm)  
Length of cutting edge (mm)

**9** Spannpratze / clamping wedge



# T&C-System Innendrehhalter / *T&C-System internal toolholders*



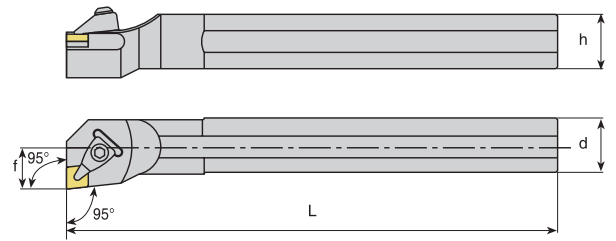
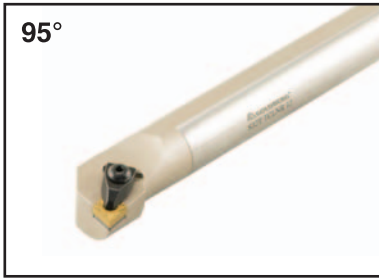

Bezeichnung Designation	Abmessungen (mm) Dimensions (mm)					Wendeplatte Insert	Ersatzteile Spare parts						
	d	h	L	f	D min		Spannpratze Wedge clamp	Spannschraube Clamp screw	Unterlage (UL) Shim	Schraube für UL Screw for shim	Druckfeder Pressure spring	Unterlegscheibe Washer	Winkelschlüssel Allen key
<b>S25S TCLNR/L 09</b>	25	23	250	17	≥32	<b>CNM. 09 03..</b>	002001	003001	001011	004004	-		
<b>S25S TCLNR/L 12</b>	25	23	250	17	≥32	<b>CNM. 12 04..</b>	002002	003002	001013	004002	006001	005001	017003
<b>S32T TCLNR/L 12</b>	32	30	300	22	≥40								
<b>S40U TCLNR/L 12</b>	40	37	350	27	≥50								
<b>S50V TCLNR/L 12</b>	50	47	400	35	≥63	<b>CNM. 16 06..</b>	002004	003005	001014	003010	-	-	017004
<b>S32T TCLNR/L 16</b>	32	30	300	22	≥40								
<b>S40U TCLNR/L 16</b>	40	37	350	27	≥50								
<b>S50V TCLNR/L 16</b>	50	47	400	35	≥63								

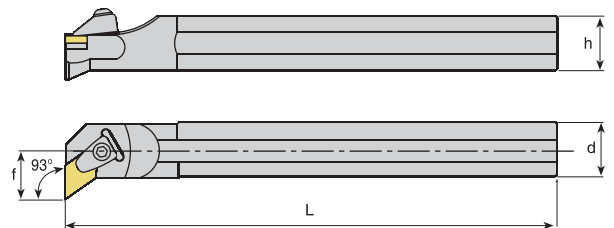

Bezeichnung Designation	Abmessungen (mm) Dimensions (mm)					Wendeplatte Insert	Ersatzteile Spare parts						
	d	h	L	f	D min		Spannpratze Wedge clamp	Spannschraube Clamp screw	Unterlage (UL) Shim	Schraube für UL Screw for shim	Druckfeder Pressure spring	Unterlegscheibe Washer	Winkelschlüssel Allen key
<b>S25S TDUNR/L 11</b>	25	23	250	17	≥32	<b>DNM. 11 04..</b>	002001	003001	001028	004004	-		
<b>S32T TDUNR/L 11</b>	32	30	300	22	≥40	<b>DNM. 15 06..</b>	002002	003002	001030	004002	006001	005001	017003
<b>S25S TDUNR/L 15</b>	25	23	250	17	≥32								
<b>S32T TDUNR/L 15</b>	32	30	300	22	≥40								
<b>S40U TDUNR/L 15</b>	40	37	350	27	≥50								
<b>S50V TDUNR/L 15</b>	50	47	400	35	≥63								

Bestellbeispiel/Ordering example: 1 Stk./pcs. S25S TDUNR 11

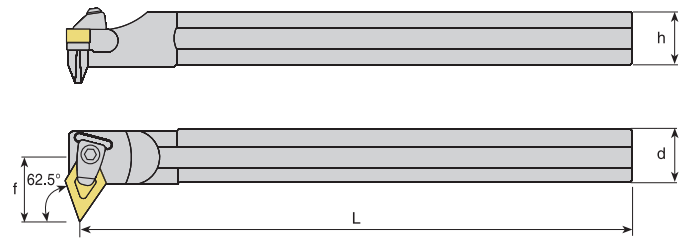

Bezeichnung Designation	Abmessungen (mm) Dimensions (mm)					Wendeplatte Insert	Ersatzteile Spare parts														
	d	h	L	f	D min		Spannpratze	Spannschraube	Unterlage (UL)	Schraube für UL	Druckfeder	Unterlegscheibe	Winkelschlüssel								
							Wedge clamp	Clamping screw	Shim	Screw for shim	Pressure spring	Washer	Allen key								
<b>S32T TD-NR/L 15</b>	32	30	300	26	≥44																
<b>S40U TD-NR/L 15</b>	40	37	350	29	≥52									<b>DNM. 15 06..</b>	002002	003002	001030	004002	006001	005001	017003
<b>S50V TD-NR/L 15</b>	50	47	400	35	≥67																

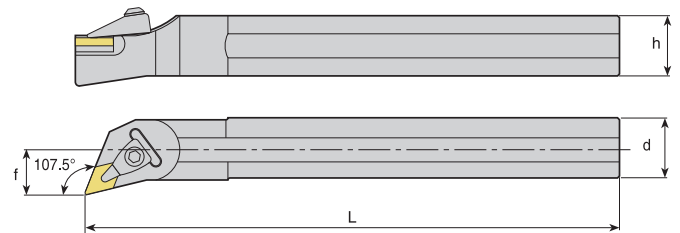

Bezeichnung Designation	Abmessungen (mm) Dimensions (mm)					Wendeplatte Insert	Ersatzteile Spare parts														
	d	h	L	f	D min		Spannpratze	Spannschraube	Unterlage (UL)	Schraube für UL	Druckfeder	Unterlegscheibe	Winkelschlüssel								
							Wedge clamp	Clamping screw	Shim	Screw for shim	Pressure spring	Washer	Allen key								
<b>S25S TDQNR/L 11</b>	25	23	250	17	≥32																
<b>S32T TDQNR/L 11</b>	32	30	300	22	≥40									<b>DNM. 11 04..</b>	002001	003001	001028	004004	-		
<b>S32T TDQNR/L 15</b>	32	30	300	22	≥40															005001	017003
<b>S40U TDQNR/L 15</b>	40	37	350	27	≥50	<b>DNM. 15 06..</b>	002002	003002	001030	004002	006001										
<b>S50V TDQNR/L 15</b>	50	47	400	35	≥63																

Bestellbeispiel/Ordering example: 1 Stk/pcs. S25S TDQNR 11

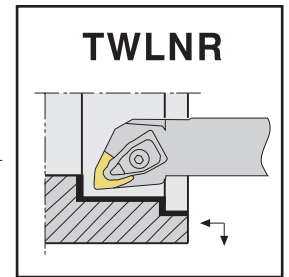
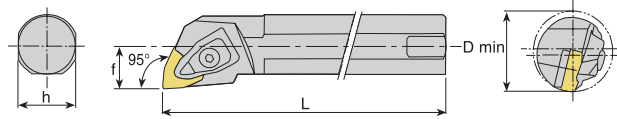

Bezeichnung Designation	Abmessungen (mm) Dimensions (mm)					Wendeplatte Insert	Ersatzteile Spare parts						
	d	h	L	f	D min		Spannpratze Wedge clamp	Spannschraube Clamping screw	Unterlage (UL) Shim	Schraube für UL Screw for shim	Druckfeder Pressure spring	Unterlegscheibe Washer	Winkelschlüssel Allen key
<b>S25S TWLNR/L 06</b>	25	23	250	17	≥32	<b>WNM. 06 04..</b>							
<b>S32T TWLNR/L 06</b>	32	30	300	22	≥40								
<b>S25S TWLNR/L 08</b>	25	23	250	17	≥32	<b>WNM. 08 04..</b>							
<b>S32T TWLNR/L 08</b>	32	30	300	22	≥40								
<b>S40U TWLNR/L 08</b>	40	37	350	27	≥50								
<b>S50V TWLNR/L 08</b>	50	47	400	35	≥63								

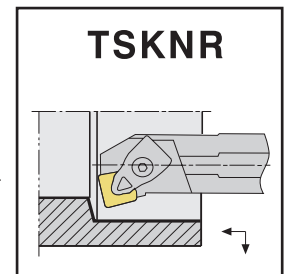
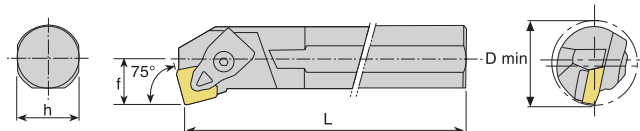

Bezeichnung Designation	Abmessungen (mm) Dimensions (mm)					Wendeplatte Insert	Ersatzteile Spare parts						
	d	h	L	f	D min		Spannpratze Clamp screw	Spannschraube Clamping screw	Unterlage (UL) Shim	Schraube für UL Screw for shim	Druckfeder Pressure spring	Unterlegscheibe Washer	Winkelschlüssel Allen key
<b>S25S TSKNR/L 12</b>	25	23	250	17	≥32	<b>SNM. 12 04..</b>							
<b>S32T TSKNR/L 12</b>	32	30	300	22	≥40								
<b>S40U TSKNR/L 12</b>	40	37	350	27	≥50								

Bestellbeispiel/Ordering example: 1 Stk/pcs. S25S TSKNR 12

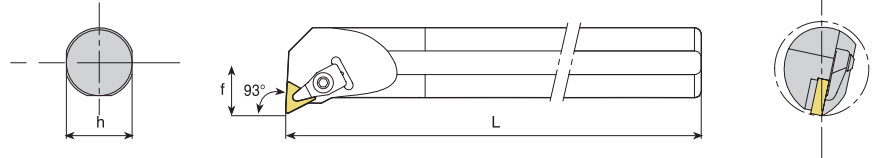

Bezeichnung Designation	Abmessungen (mm) Dimensions (mm)					Wendeplatte Insert	Ersatzteile Spare parts													
	d	h	L	f	D min		Spannpratze	Spannschraube	Unterlage (UL)	Schraube für UL	Druckfeder	Unterlegscheibe	Winkelschlüssel							
							Wedge clamp	clamping screw	Shim	Srew for shim	Pressure spring	Washer	Allen key							
<b>S25S TTUNR/L 16</b>	25	23	250	17	≥32															
<b>S32T TTUNR/L 16</b>	32	30	300	22	≥40									TNM. 16 04..	002001	003001	001002	004003	-	
<b>S32T TTUNR/L 22</b>	32	30	300	22	≥40															
<b>S40U TTUNR/L 22</b>	40	37	350	27	≥50									TNM. 22 04..	002002	003002	001004	004002	006001	
<b>S50V TTUNR/L 22</b>	50	47	400	35	≥63															

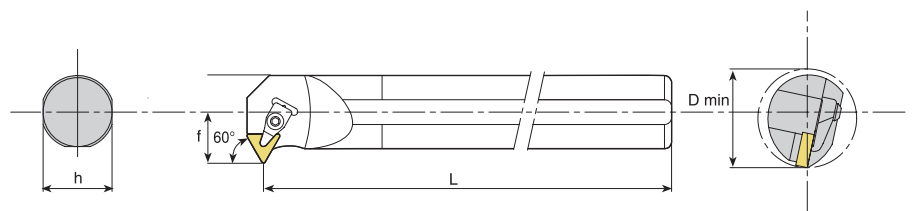

Bezeichnung Designation	Abmessungen (mm) Dimensions (mm)					Wendeplatte Insert	Ersatzteile Spare parts						
	d	h	L	f	D min		Spannpratze	Spannschraube	Unterlage (UL)	Schraube für UL	Druckfeder	Unterlegscheibe	Winkelschlüssel
							Wedge clamp	clamping screw	Shim	Srew for shim	Pressure spring	Washer	Allen key
<b>S25S TT-NR/L 16</b>	25	23	250	17	≥32								
<b>S32T TT-NR/L 16</b>	32	30	300	22	≥40								

Bestellbeispiel/Ordering example: 1 Stk/pcs. S25S TT-NR 16

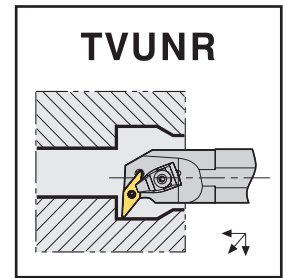
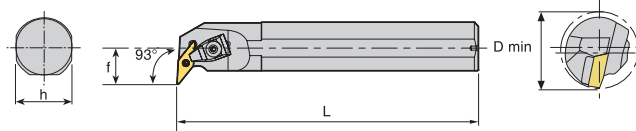

Bezeichnung Designation	Abmessungen (mm) Dimensions (mm)					Wendeplatte Insert	Ersatzteile Spare parts														
	d	h	L	f	D min		Spannpratze	Spannschraube	Unterlage (UL)	Schraube für UL	Druckfeder	Unterlegscheibe	Winkelschlüssel								
							Wedge clamp	clamping screw	Shim	Screw for shim	Pressure spring	Washer	Allen key								
<b>S25S TVUNR/L 16</b>	25	23	250	17	≥32																
<b>S32T TVUNR/L 16</b>	32	30	300	22	≥40									VNM. 16 04..	002001	003001	001032	004004	-	005001	017003
<b>S40U TVUNR/L 16</b>	40	37	350	27	≥50																

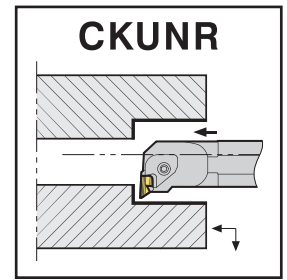
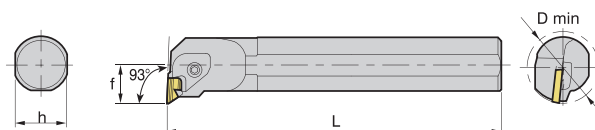

Bezeichnung Designation	Abmessungen (mm) Dimensions (mm)					Wendeplatte Insert	Ersatzteile Spare Parts														
	d	h	L	f	D min		Spannpratze	Spannschraube	Unterlage (UL)	Schraube für UL	Druckfeder	Unterlegscheibe	Winkelschlüssel								
							Wedge clamp	clamping screw	Shim	Screw for shim	Pressure spring	Washer	Allen key								
<b>S25S CKUNR/L 16</b>	25	23	250	19	≥34																
<b>S32T CKUNR/L 16</b>	32	30	300	22	≥40									KNUX 16 04..	002010-R	003006	001020	004001	006002	005001	017004
<b>S40U CKUNR/L 16</b>	40	37	350	27	≥50										002011-L		001019				
<b>S50V CKUNR/L 16</b>	50	47	400	35	≥63																

Bestellbeispiel/Ordering example: 1 Stk./pcs. S25S CKUNR 16



M-System Innendrehhalter /  
*M-System internal toolholders*



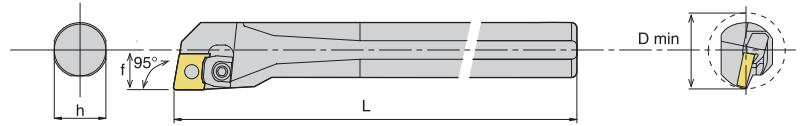

Bezeichnung Designation	Abmessungen (mm) Dimensions (mm)					Wendeplatte Insert	Ersatzteile Spare parts												
	d	h	L	f	D min		Spannpratze Clamp	Spannschraube Clamping screw	Unterlage Shim	Stift Pin	Unterlegscheibe Washer	Winkelschlüssel Allen key							
<b>S20R MCLNR/L 12</b>	20	18	200	13	≥25														
<b>S25S MCLNR/L 12</b>	25	23	250	17	≥32								<b>CNM. 12 04..</b>	002007	003004	001013	007004	-	017003
<b>S32T MCLNR/L 12</b>	32	30	300	22	≥40														

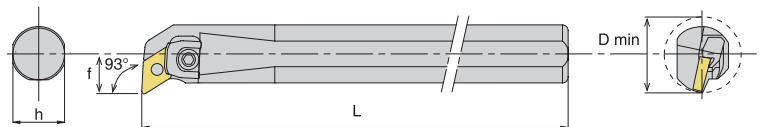

Bezeichnung Designation	Abmessungen (mm) Dimensions (mm)					Wendeplatte Insert	Ersatzteile Spare parts												
	d	h	L	f	D min		Spannpratze Clamp	Spannschraube Clamping screw	Unterlage Shim	Stift Pin	Unterlegscheibe Washer	Winkelschlüssel Allen key							
<b>S20R MDUNR/L 11</b>	20	18	200	13	≥25														
<b>S25S MDUNR/L 11</b>	25	23	250	17	≥32								<b>DNM. 11 04..</b>	002007	003004	-	007003	-	017003
<b>S32T MDUNR/L 11</b>	32	30	300	22	≥40														
<b>S25S MDUNR/L 15</b>	25	23	250	17	≥32														
<b>S32T MDUNR/L 15</b>	32	30	300	22	≥40								<b>DNM. 15 06..</b>	002008	003002	001030	007004	005001	
<b>S40U MDUNR/L 15</b>	40	37	350	27	≥50														
<b>S50V MDUNR/L 15</b>	50	47	400	35	≥63														

Bestellbeispiel/Ordering example: 1 Stk./pcs. S20R MDUNR 11

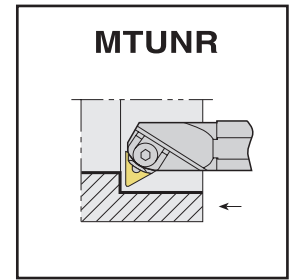
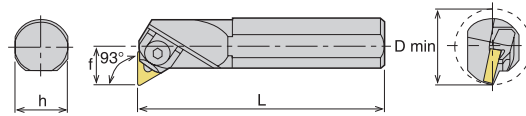

Bezeichnung Designation	Abmessungen (mm) Dimensions (mm)					Wendeplatte Insert	Ersatzteile Spare parts					
	d	h	L	f	D min		Spannpratze Clamp	Spannschraube Clamping screw	Unterlage Shim	Stift Pin	Unterlegscheibe Washer	Winkelschlüssel Allen key
<b>S20R MTUNR/L 16</b>	20	18	200	13	≥25	<b>TNM. 16 04..</b>			-	007003	-	
<b>S25S MTUNR/L 16</b>	25	23	250	17	≥32				001002	007001		
<b>S32T MTUNR/L 16</b>	32	30	300	22	≥40							
<b>S40U MTUNR/L 16</b>	40	37	350	27	≥50				002008	003002	005001	
<b>S32T MTUNR/L 22</b>	32	30	300	22	≥40	001004	007002					
<b>S40U MTUNR/L 22</b>	40	37	350	27	≥50			<b>TNM. 22 04..</b>				
<b>S50V MTUNR/L 22</b>	50	47	400	35	≥63							

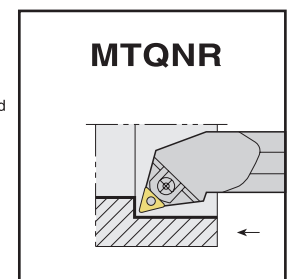
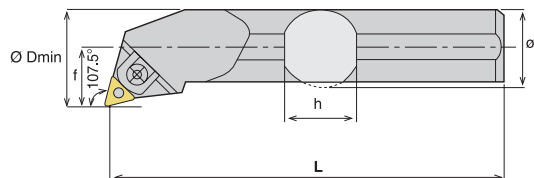

Bezeichnung Designation	Abmessungen (mm) Dimensions (mm)					Wendeplatte Insert	Ersatzteile Spare parts					
	d	h	L	f	D min		Spannpratze Clamp	Spannschraube Clamping screw	Unterlage Shim	Stift Pin	Unterlegscheibe Washer	Winkelschlüssel Allen key
<b>S20R MTQNR/L 16</b>	20	18	200	13	≥25	<b>TNM. 16 04..</b>			-	007003	-	
<b>S25S MTQNR/L 16</b>	25	23	250	17	≥32				001002	007001		
<b>S32T MTQNR/L 16</b>	32	30	300	22	≥40							
<b>S40U MTQNR/L 16</b>	40	37	350	27	≥50				002008	003002	005001	
<b>S32T MTQNR/L 22</b>	32	30	300	22	≥40	001004	007002					
<b>S40U MTQNR/L 22</b>	40	37	350	27	≥50			<b>TNM. 22 04..</b>				
<b>S50V MTQNR/L 22</b>	50	47	400	35	≥63							

Bestellbeispiel/Ordering example: 1 Stk/pcs. S20R MTQNR 16

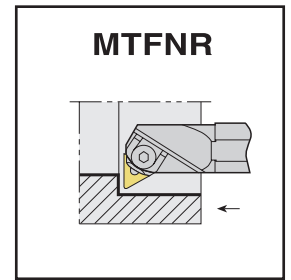
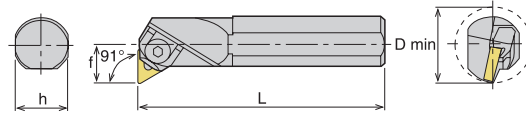

Bezeichnung Designation	Abmessungen (mm) Dimensions (mm)					Wendeplatte Insert	Ersatzteile Spare parts					
	d	h	L	f	D min		Spannpratze Clamp	Spannschraube Clamping screw	Unterlage Shim	Stift Pin	Unterlegscheibe Washer	Winkelschlüssel Allen key
									-	007003	-	-
<b>S20R MTFNR/L 16</b>	20	18	200	13	≥25	TNM. 16 04..	002006	003004	-	007003	-	017003
<b>S25S MTFNR/L 16</b>	25	23	250	17	≥32				001002	007001	005001	
<b>S32T MTFNR/L 16</b>	32	30	300	22	≥40				001004	007002		
<b>S40U MTFNR/L 16</b>	40	37	350	27	≥50	TNM. 22 04..	002008	003002	-	007001	005001	017003
<b>S32T MTFNR/L 22</b>	32	30	300	22	≥40				001002	007001		
<b>S40U MTFNR/L 22</b>	40	37	350	27	≥50				001004	007002		
<b>S50V MTFNR/L 22</b>	50	47	400	35	≥63							

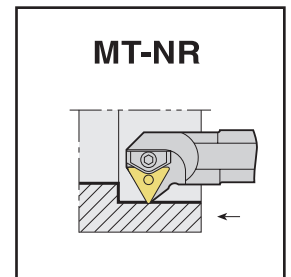
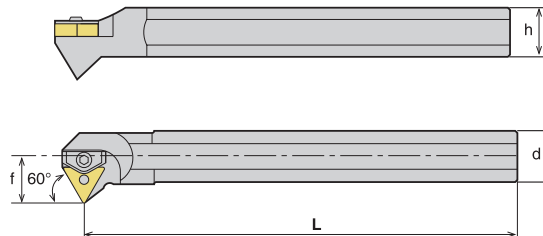

Bezeichnung Designation	Abmessungen (mm) Dimensions (mm)					Wendeplatte Insert	Ersatzteile Spare parts					
	d	h	L	f	D min		Spannpratze Clamp	Spannschraube Clamping screw	Unterlage Shim	Stift Pin	Unterlegscheibe Washer	Winkelschlüssel Allen key
									-	007003	-	-
<b>S20R MT-NR/L 16</b>	20	18	200	13	≥25	TNM. 16 04..	002006	003004	-	007003	-	017003
<b>S25S MT-NR/L 16</b>	25	23	250	17	≥32				001002	007001	005001	
<b>S32T MT-NR/L 16</b>	32	30	300	22	≥40				001004	007002		
<b>S40U MT-NR/L 16</b>	40	37	350	27	≥50	TNM. 22 04..	002008	003002	-	007001	005001	017003
<b>S40U MT-NR/L 22</b>	40	37	350	27	≥50				001002	007001		
									001004	007002		

Bestellbeispiel/Ordering example: 1 Stk/pcs. S20R MT-NR 16

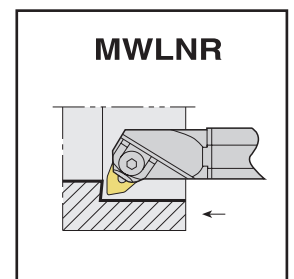
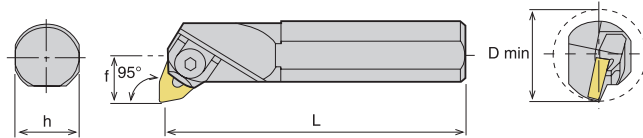

Bezeichnung Designation	Abmessungen (mm) Dimensions (mm)					Wendeplatte Insert	Ersatzteile Spare parts					
	d	h	L	f	D min		Spannpratze Clamp	Spannschraube Clamping screw	Unterlage Shim	Stift Pin	Unterlegscheibe Washer	Winkelschlüssel Allen key
<b>S16P MWLNR/L 06</b>	16	15	170	11	≥21		002005	003016	-	007003	-	017003
<b>S20R MWLNR/L 06</b>	20	18	200	13	≥25			003004				
<b>S25S MWLNR/L 06</b>	25	23	250	17	≥32							
<b>S25S MWLNR/L 08</b>	25	23	250	17	≥32		002009	003003	001017	007002	005001	017003
<b>S32T MWLNR/L 08</b>	32	30	300	22	≥40							
<b>S40U MWLNR/L 08</b>	40	37	350	27	≥50							







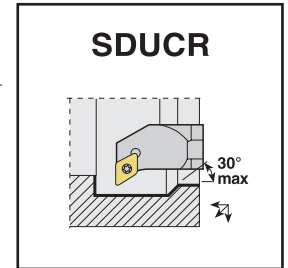
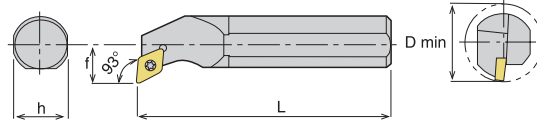

Bestellbeispiel/Ordering example: 1 Stk/pcs. S16P MWLNR 06

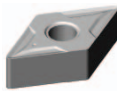
S-System Innendrehhalter /  
*S-System internal toolholders*





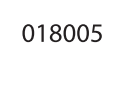

Bezeichnung Designation	Abmessungen (mm) Dimensions (mm)					Wendeplatte Insert	Ersatzteile Spare parts			
	d	h	L	f	D min		Spannschraube Clamping screw	Unterlage (UL) Shim	Schraube für UL Screw for shim	Torx Schlüssel Torx key
<b>S10K SDUCR/L 07</b>	10	09	125	07	≥13					
<b>S12K SDUCR/L 07</b>	12	11	125	09	≥16					
<b>S16P SDUCR/L 07</b>	16	15	170	11	≥21					
<b>S20R SDUCR/L 07</b>	20	18	200	13	≥25					
<b>A10H SDUCR/L 07</b>	10	09	100	07	≥13					
<b>A12H SDUCR/L 07</b>	12	11	100	09	≥16					
<b>A16M SDUCR/L 07</b>	16	15	150	11	≥21					
<b>A20P SDUCR/L 07</b>	20	18	170	13	≥25					
<b>S16P SDUCR/L 11</b>	16	15	170	11	≥21					
<b>S20R SDUCR/L 11</b>	20	18	200	13	≥25					
<b>S25S SDUCR/L 11</b>	25	23	250	17	≥32					
<b>S32T SDUCR/L 11</b>	32	30	300	22	≥40					
<b>S40U SDUCR/L 11</b>	40	37	350	27	≥50					
<b>A16M SDUCR/L 11</b>	16	15	150	11	≥21					
<b>A20P SDUCR/L 11</b>	20	18	170	13	≥25					
<b>A25R SDUCR/L 11</b>	25	23	200	17	≥32					
<b>A32S SDUCR/L 11</b>	32	30	250	22	≥40					

Bestellbeispiel/Ordering example: 1 Stk/pcs. S10K SDUCR 07

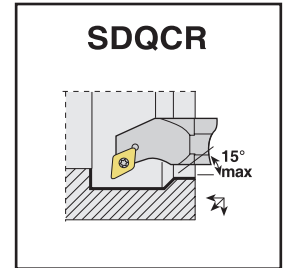
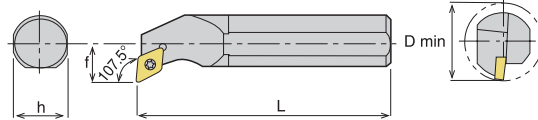

Bezeichnung Designation	Abmessungen (mm) Dimensions (mm)					Wendeplatte Insert	Ersatzteile Spare parts			
	d	h	L	f	D min		Spannschraube Clamping screw	Unterlage (UL) Shim	Schraube für UL Screw for shim	Torx Schlüssel Torx key
<b>S10K SDQCR/L 07</b>	10	09	125	07	≥13	<b>DCM. 07 02..</b> 	011007 	-	-	018003 
<b>S12K SDQCR/L 07</b>	12	11	125	09	≥16					
<b>S16P SDQCR/L 07</b>	16	15	170	11	≥21					
<b>S20R SDQCR/L 07</b>	20	18	200	13	≥25					
<b>A10H SDQCR/L 07</b>	10	09	100	07	≥13					
<b>A12H SDQCR/L 07</b>	12	11	100	09	≥16					
<b>A16M SDQCR/L 07</b>	16	15	150	11	≥21					
<b>A20P SDQCR/L 07</b>	20	18	170	13	≥25					
<b>S16P SDQCR/L 11</b>	16	15	170	11	≥21	<b>DCM. 11 T3..</b> 	011014 	-	-	018005 
<b>S20R SDQCR/L 11</b>	20	18	200	13	≥25					
<b>S25S SDQCR/L 11</b>	25	23	250	17	≥32					
<b>S32T SDQCR/L 11</b>	32	30	300	22	≥40					
<b>S40U SDQCR/L 11</b>	40	37	350	27	≥50					
<b>A16M SDQCR/L 11</b>	16	15	150	11	≥21					
<b>A20P SDQCR/L 11</b>	20	18	170	13	≥25					
<b>A25R SDQCR/L 11</b>	25	23	200	17	≥32					
<b>A32S SDQCR/L 11</b>	32	30	250	22	≥40	011042 	001028 	004006 		

Bestellbeispiel/Ordering example: 1 Stk/pcs. S10K SDQCR 07

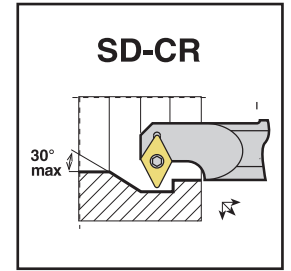
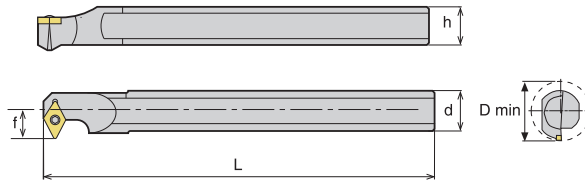

Bezeichnung Designation	Abmessungen (mm) Dimensions (mm)					Wendeplatte Insert	Ersatzteile Spare parts			
	d	h	L	f	D min		Spannschraube Clamping screw	Unterlage (UL) Shim	Schraube für UL Screw for shim	Torx Schlüssel Torx key
<b>S12K SD-CR/L 07</b>	12	11	125	09	≥17	<b>DCM. 07 02..</b>	011007	-	-	018003
<b>S16P SD-CR/L 07</b>	16	15	170	11	≥21					
<b>S20R SD-CR/L 07</b>	20	18	200	13	≥25					
<b>S16P SD-CR/L 11</b>	16	15	170	11	≥21	<b>DCM. 11 T3..</b>	011014	-	-	018005
<b>S20R SD-CR/L 11</b>	20	18	200	13	≥25					
<b>S25S SD-CR/L 11</b>	25	23	250	17	≥32					
<b>S32T SD-CR/L 11</b>	32	30	300	22	≥40					
<b>S40U SD-CR/L 11</b>	40	37	350	27	≥50		011042	001028	004006	

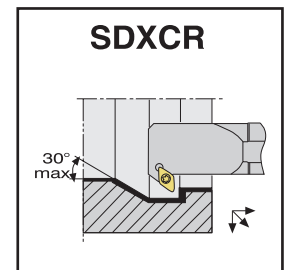
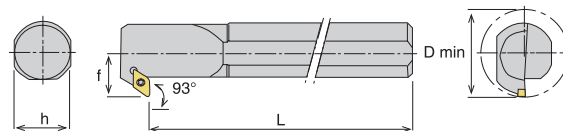

Bezeichnung Designation	Abmessungen (mm) Dimensions (mm)					Wendeplatte Insert	Ersatzteile Spare parts			
	d	h	L	f	D min		Spannschraube Clamping screw	Unterlage (UL) Shim	Schraube für UL Screw for shim	Torx Schlüssel Torx key
<b>S12K SDXCR/L 07</b>	12	11	125	09	≥17	<b>DCM. 07 02..</b>	011007	-	-	018003
<b>S16P SDXCR/L 07</b>	16	15	170	11	≥21					
<b>S20R SDXCR/L 07</b>	20	18	200	13	≥25					
<b>S16P SDXCR/L 11</b>	16	15	170	11	≥21	<b>DCM. 11 T3..</b>	011014	-	-	018005
<b>S20R SDXCR/L 11</b>	20	18	200	13	≥25					
<b>S25S SDXCR/L 11</b>	25	23	250	17	≥32					
<b>S32T SDXCR/L 11</b>	32	30	300	22	≥40					
<b>S40U SDXCR/L 11</b>	40	37	350	27	≥50		011042	001028	004006	

Bestellbeispiel/Ordering example: 1 Stk./pcs. S12K SDXCR 07

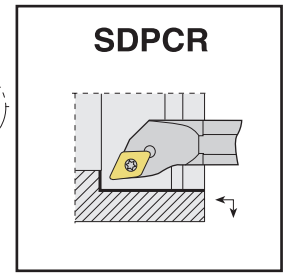
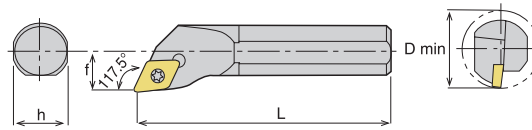

Bezeichnung Designation	Abmessungen (mm) Dimensions (mm)					Wendeplatte Insert	Ersatzteile Spare parts								
	d	h	L	f	D min		Spannschraube Clamping screw	Unterlage (UL) Shim	Schraube für UL Screw for shim	Torx Schlüssel Torx key					
<b>S10K SDPCR/L 07</b>	10	09	125	07	≥13			-	-						
<b>S12K SDPCR/L 07</b>	12	11	125	09	≥16						DCM. 07 02..	011007	-	-	018003
<b>S16P SDPCR/L 11</b>	16	15	170	11	≥21			-	-						
<b>S20R SDPCR/L 11</b>	20	18	200	13	≥25						DCM. 11 T3..	011014	-	-	018005
<b>S25S SDPCR/L 11</b>	25	23	250	17	≥32							011042	001028	004006	

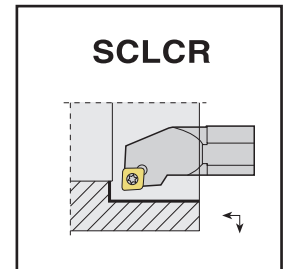
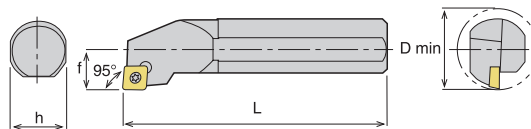

Bezeichnung Designation	Abmessungen (mm) Dimensions (mm)					Wendeplatte Insert	Ersatzteile Spare parts								
	d	h	L	f	D min		Spannschraube Clamping screw	Unterlage (UL) Shim	Schraube für UL Screw for shim	Torx Schlüssel Torx key					
<b>S0608H SCLCR/L 06</b>	06	07	100	4,5	≥8				-						
<b>S08H SCLCR/L 06</b>	08	07	100	06	≥11						CCM. 06 02..	011006	-	-	018003
<b>S10K SCLCR/L 06</b>	10	09	125	07	≥13							011007	-	-	
<b>S12K SCLCR/L 06</b>	12	11	125	09	≥16							011006	-	-	
<b>A08H SCLCR/L 06</b>	08	07	100	06	≥11							011007	-	-	
<b>A10H SCLCR/L 06</b>	10	09	100	07	≥13							011007	-	-	
<b>S12K SCLCR/L 09</b>	12	11	125	09	≥16				-						
<b>S16P SCLCR/L 09</b>	16	15	170	11	≥21						CCM. 09 T3..	011014	-	-	018005
<b>S20R SCLCR/L 09</b>	20	19	200	13	≥25							011042	001011	004006	
<b>S25S SCLCR/L 09</b>	25	23	250	17	≥32							011042	001011	004006	
<b>S32T SCLCR/L 09</b>	32	30	300	22	≥40							011014	-	-	
<b>A16M SCLCR/L 09</b>	16	15	150	11	≥21							011042	001011	004006	
<b>A20P SCLCR/L 09</b>	20	19	170	13	≥25							011042	001011	004006	
<b>A25R SCLCR/L 09</b>	25	23	200	17	≥32				-						
<b>A32S SCLCR/L 09</b>	32	30	250	22	≥40						CCM. 12 04..	011037	001012	004007	018006
<b>S25S SCLCR/L 12</b>	25	23	250	17	≥32										
<b>S32T SCLCR/L 12</b>	32	30	300	22	≥40										
<b>S40U SCLCR/L 12</b>	40	37	350	27	≥50										
<b>A25R SCLCR/L 12</b>	25	23	200	17	≥32										

Bestellbeispiel/Ordering example: 1 Stk/pcs. S0608H SCLCR 06

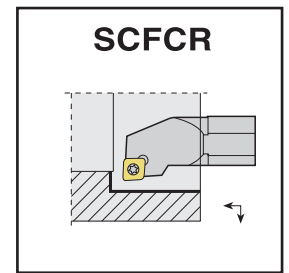
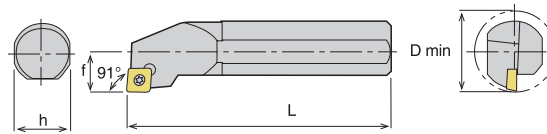

Bezeichnung Designation	Abmessungen (mm) Dimensions (mm)					Wendeplatte Insert	Ersatzteile Spare parts					
	d	h	L	f	D min		Spannschraube Clamping screw	Unterlage (UL) Shim	Schraube für UL Screw for shim	Torx Schlüssel Torx key		
<b>S08H SCFCR/L 06</b>	08	07	100	06	≥11		011006					
<b>S10K SCFCR/L 06</b>	10	09	125	07	≥13		<b>CCM. 06 02..</b>				018003	
<b>S12K SCFCR/L 06</b>	12	11	125	09	≥16			-	-			
<b>S16P SCFCR/L 09</b>	16	15	170	11	≥21		011014					
<b>S20R SCFCR/L 09</b>	20	19	200	13	≥25		<b>CCM. 09 T3..</b>				018005	
<b>S25S SCFCR/L 09</b>	25	23	250	17	≥32			011042	001011		004006	
<b>S25S SCFCR/L 12</b>	25	23	250	17	≥32		011037					
<b>S32T SCFCR/L 12</b>	32	30	300	22	≥40		<b>CCM. 12 04..</b>		001012		004007	018006
<b>S40U SCFCR/L 12</b>	40	37	350	27	≥50							

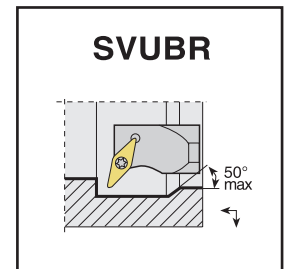
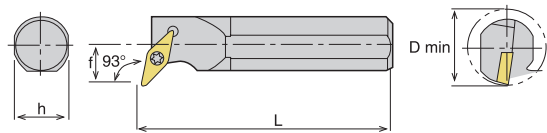

Bezeichnung Designation	Abmessungen (mm) Dimensions (mm)					Wendeplatte Insert	Ersatzteile Spare parts				
	d	h	L	f	D min		Spannschraube Clamping screw	Unterlage (UL) Shim	Schraube für UL Screw for shim	Torx Schlüssel Torx key	
<b>S16P SVUBR/L 11</b>	16	15	170	11	≥21		011007				
<b>S20R SVUBR/L 11</b>	20	18	200	13	≥25		<b>VBM. 11 03..</b>				018003
<b>S25S SVUBR/L 16</b>	25	23	250	17	≥32						
<b>S32T SVUBR/L 16</b>	32	30	300	22	≥40		011042	001032	004006		
<b>S40U SVUBR/L 16</b>	40	37	350	27	≥50		<b>VBM. 16 04..</b>				018005

Bestellbeispiel/Ordering example: 1 Stk/pcs. S16P SVUBR 11

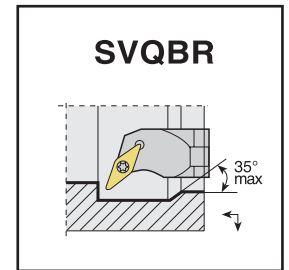
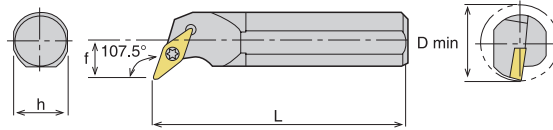

Bezeichnung Designation	Abmessungen (mm) Dimensions (mm)					Wendeplatte Insert	Ersatzteile Spare parts			
	d	h	L	f	D min		Spannschraube Clamping screw	Unterlage (UL) Shim	Schraube für UL Screw for shim	Torx Schlüssel Torx key
S16P SVQBR/L 11 S20R SVQBR/L 11	16 20	15 18	170 200	11 13	≥21 ≥25	VBM. 11 03..	011007	-	-	018003
S25S SVQBR/L 16 S32T SVQBR/L 16 S40U SVQBR/L 16	25 32 40	23 30 37	250 300 350	17 22 27	≥32 ≥40 ≥50	VBM. 16 04..	011042	001032	004006	018005

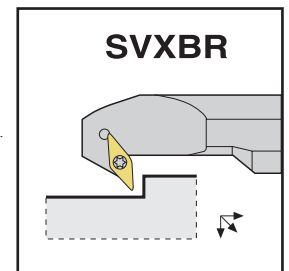
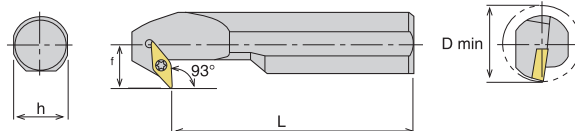

Bezeichnung Designation	Abmessungen (mm) Dimensions (mm)					Wendeplatte Insert	Ersatzteile Spare parts			
	d	h	L	f	D min		Spannschraube Clamping screw	Unterlage (UL) Shim	Schraube für UL Screw for shim	Torx Schlüssel Torx key
S16P SVXBR/L 11 S20R SVXBR/L 11	16 20	15 18	170 200	11 13	≥21 ≥25	VBM. 11 03..	011007	-	-	018003
S25S SVXBR/L 16 S32T SVXBR/L 16 S40U SVXBR/L 16	25 32 40	23 30 37	250 300 350	17 22 27	≥32 ≥40 ≥50	VBM. 16 04..	011042	001032	004006	018005

Bestellbeispiel/Ordering example: 1 Stk./pcs. S16P SVXBR 11



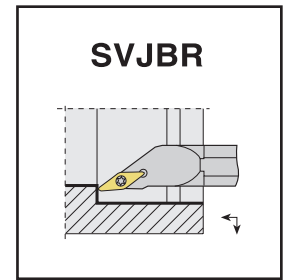
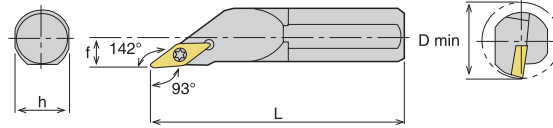

Bezeichnung Designation	Abmessungen (mm) Dimensions (mm)					Wendeplatte Insert	Ersatzteile Spare parts			
	d	h	L	f	D min		Spannschraube Clamping screw	Unterlage (UL) Shim	Schraube für UL Screw for shim	Torx Schlüssel Torx key
<b>S25S SVJBR/L 16</b>	25	23	250	17	≥32					
<b>S32T SVJBR/L 16</b>	32	30	300	22	≥40					
<b>S40U SVJBR/L 16</b>	40	37	350	27	≥50					
						<b>VBM. 16 04..</b>	011042	001032	004006	018005

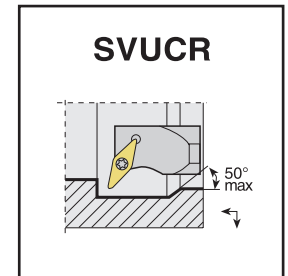
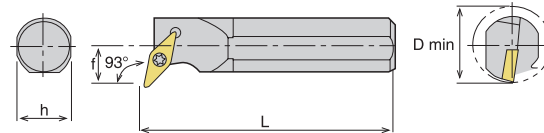

Bezeichnung Designation	Abmessungen (mm) Dimensions (mm)					Wendeplatte Insert	Ersatzteile Spare parts			
	d	h	L	f	D min		Spannschraube Clamping screw	Unterlage (UL) Shim	Schraube für UL Screw for shim	Torx Schlüssel Torx key
<b>S16P SVUCR/L 11</b>	16	15	170	11	≥21			-	-	
<b>S20R SVUCR/L 11</b>	20	18	200	13	≥25					
<b>S25S SVUCR/L 16</b>	25	23	250	17	≥32					
<b>S32T SVUCR/L 16</b>	32	30	300	22	≥40					
<b>S40U SVUCR/L 16</b>	40	37	350	27	≥50					
						<b>VCM. 11 03..</b>	011007	-	-	018003
						<b>VCM. 16 04..</b>	011042	001032	004006	018005

Bestellbeispiel/Ordering example: 1 Stk/pcs. S16P SVUCR 11

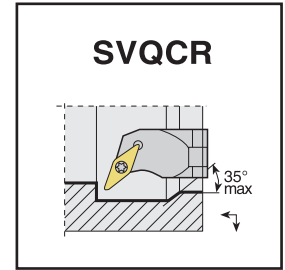
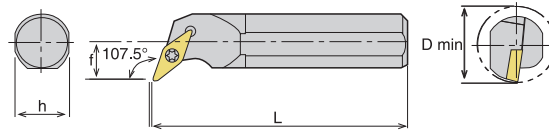

Bezeichnung Designation	Abmessungen (mm) Dimensions (mm)					Wendeplatte Insert	Ersatzteile Spare parts			
	d	h	L	f	D min		Spannschraube Clamping screw	Unterlage (UL) Shim	Schraube für UL Screw for shim	Torx Schlüssel Torx key
<b>S16P SVQCR/L 11</b> <b>S20R SVQCR/L 11</b>	16	15	170	11	≥21			-	-	018003
<b>S25S SVQCR/L 16</b> <b>S32T SVQCR/L 16</b> <b>S40U SVQCR/L 16</b>	25	23	250	17	≥32					
	20	18	200	13	≥25					
	32	30	300	22	≥40					

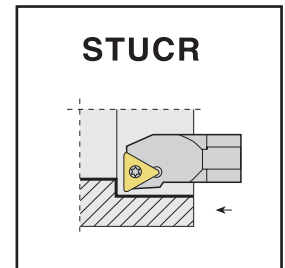
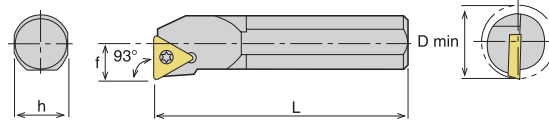

Bezeichnung Designation	Abmessungen (mm) Dimensions (mm)					Wendeplatte Insert	Ersatzteile Spare parts								
	d	h	L	f	D min		Spannschraube Clamping screw	Unterlage (UL) Shim	Schraube für UL Screw for shim	Torx Schlüssel Torx key					
<b>S10K STUCR/L 09</b> <b>S12K STUCR/L 09</b>	10	9	125	07	≥13			-	-	018002					
<b>S12K STUCR/L 11</b> <b>S16P STUCR/L 11</b> <b>S20R STUCR/L 11</b>	12	11	125	09	≥17						<b>TCM. 11 02..</b>	011007	-	-	018003
<b>S16P STUCR/L 16</b> <b>S20R STUCR/L 16</b> <b>S25S STUCR/L 16</b> <b>S32T STUCR/L 16</b> <b>S40U STUCR/L 16</b>	16	15	170	11	≥21	<b>TCM. 16 T3..</b>	011014	-	-	018005					
	12	11	125	09	≥17										
	20	18	200	13	≥25										
	25	23	250	17	≥32										
	32	30	300	22	≥40										

Bestellbeispiel/Ordering example: 1 Stk/pcs. S10K STUCR 09

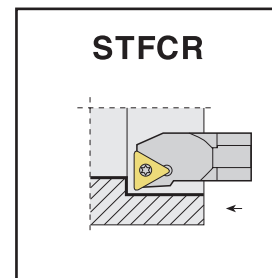
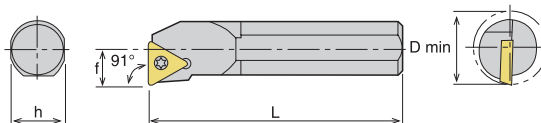

Bezeichnung Designation	Abmessungen (mm) Dimensions (mm)					Wendeplatte Insert	Ersatzteile Spare parts			
	d	h	L	f	D min		Spannschraube Clamping screw	Unterlage (UL) Shim	Schraube für UL Screw for shim	Torx Schlüssel Torx key
<b>S0610F STF-CR/L 06</b>	10	9	125	04	≥08					
<b>S10K STF-CR/L 09</b>	10	9	125	07	≥13					
<b>S12K STF-CR/L 09</b>	12	11	125	09	≥17			-	-	
<b>S12K STF-CR/L 11</b>	12	11	125	09	≥17					
<b>S16P STF-CR/L 11</b>	16	15	170	11	≥21			-	-	
<b>S20R STF-CR/L 11</b>	20	18	200	13	≥25					
<b>S16P STF-CR/L 16</b>	16	15	170	11	≥21					
<b>S20R STF-CR/L 16</b>	20	18	200	13	≥25					
<b>S25S STF-CR/L 16</b>	25	23	250	17	≥32					
<b>S32T STF-CR/L 16</b>	32	30	300	22	≥40					
<b>S40U STF-CR/L 16</b>	40	37	350	27	≥50					

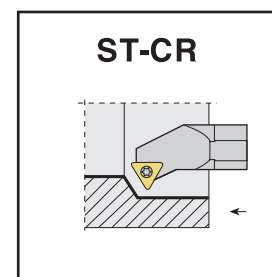
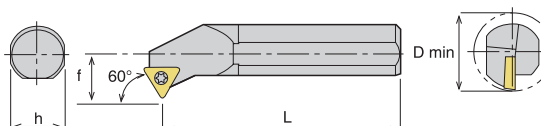

Bezeichnung Designation	Abmessungen (mm) Dimensions (mm)					Wendeplatte Insert	Ersatzteile Spare parts			
	d	h	L	f	D min		Spannschraube Clamping screw	Unterlage (UL) Shim	Schraube für UL Screw for shim	Torx Schlüssel Torx key
<b>S12K ST-CR/L 11</b>	12	11	125	09	≥17			-	-	
<b>S16P ST-CR/L 11</b>	16	15	170	11	≥21					
<b>S20R ST-CR/L 11</b>	20	18	200	13	≥25			-	-	
<b>S16P ST-CR/L 16</b>	16	15	170	11	≥21					
<b>S20R ST-CR/L 16</b>	20	18	200	13	≥25					
<b>S25S ST-CR/L 16</b>	25	23	250	17	≥32					
<b>S32T ST-CR/L 16</b>	32	30	300	22	≥40					
<b>S40U ST-CR/L 16</b>	40	37	350	27	≥50					

Bestellbeispiel/Ordering example: 1 Stk/pcs. S12K ST-CR 11

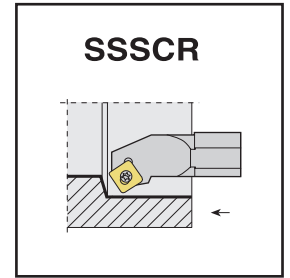
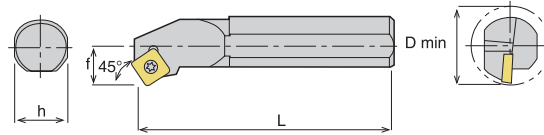
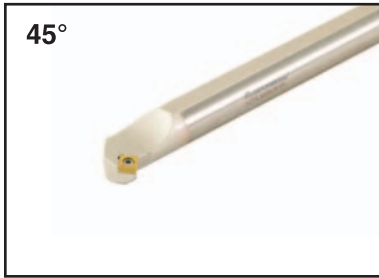

Bezeichnung Designation	Abmessungen (mm) Dimensions (mm)					Wendeplatte Insert	Ersatzteile Spare parts			
	d	h	L	f	D min		Spanschraube Clamping screw	Unterlage (UL) Shim	Schraube für UL Screw for shim	Torx Schlüssel Torx key
<b>S16P SSSCR/L 09</b>	16	15	170	11	≥21					
<b>S20R SSSCR/L 09</b>	20	18	200	13	≥25					
<b>S25S SSSCR/L 09</b>	25	23	250	17	≥32					
<b>S32T SSSCR/L 12</b>	32	30	300	22	≥40					
<b>S40U SSSCR/L 12</b>	40	37	350	27	≥50					

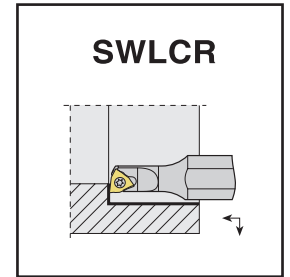
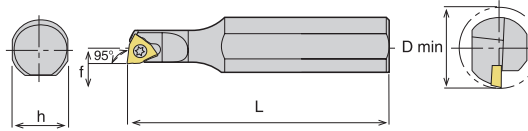

Bezeichnung Designation	Abmessungen (mm) Dimensions (mm)					Wendeplatte Insert	Ersatzteile Spare parts			
	d	h	L	f	D min		Spanschraube Clamping screw	Unterlage (UL) Shim	Schraube für UL Screw for shim	Torx Schlüssel Torx key
<b>S0608H SWLCR 03</b>	08	05	100	04	≥08					
<b>S0810K SWLCR 03</b>	10	07	125	07	≥10					

Bestellbeispiel/Ordering example: 1 Stk/pcs, S0608H SWLCR 03

P-System Innendrehhalter /  
*P-System internal toolholders*



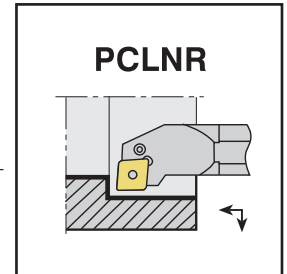
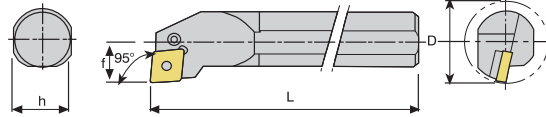

Bezeichnung Designation	Abmessungen (mm) Dimensions (mm)					Wendeplatte Insert	Ersatzteile Spare parts						
	d	h	L	f	D min		Hebel (H) Lever	Schraube für H Screw for lever	Unterlage (UL) Shim	Druckfeder für UL Pressure spring	Spannpratze Clamp	Spannschraube Clamping screw	Winkelschlüssel Allen key
<b>S16P PCLNR/L 09</b>	16	15	170	11	≥21	<b>CNM. 09 03..</b>							
<b>S20R PCLNR/L 09</b>	20	18	200	13	≥25								
<b>S25S PCLNR/L 09</b>	25	23	250	17	≥32								
<b>S25S PCLNR/L 12C</b>	25	23	250	17	≥32	<b>CNM. 12 04..</b>							
<b>S32T PCLNR/L 12C</b>	32	30	300	22	≥40								
<b>S40U PCLNR/L 12C</b>	40	37	350	27	≥50								
<b>S50V PCLNR/L 12C</b>	50	47	400	35	≥63								
<b>A25R PCLNR/L 12C</b>	25	23	200	17	≥32								
<b>A32S PCLNR/L 12C</b>	32	30	250	22	≥40								
<b>A40T PCLNR/L 12C</b>	40	37	300	27	≥50	<b>CNM. 16 06..</b>							
<b>A50U PCLNR/L 12C</b>	50	47	350	35	≥63								
<b>S32T PCLNR/L 16</b>	32	30	300	22	≥40								
<b>S40U PCLNR/L 16</b>	40	37	350	27	≥50								
<b>S50V PCLNR/L 16</b>	50	47	400	35	≥63								
<b>A32S PCLNR/L 16C</b>	32	30	250	22	≥40								
<b>A40T PCLNR/L 16</b>	40	37	300	27	≥50	<b>CNM. 19 06..</b>							
<b>A50U PCLNR/L 16C</b>	50	47	350	35	≥63								
<b>S40U PCLNR/L 19C</b>	40	37	350	27	≥50								
<b>S50V PCLNR/L 19C</b>	50	47	400	35	≥63								
<b>A40T PCLNR/L 19C</b>	40	37	300	27	≥50								
<b>A50U PCLNR/L 19C</b>	50	47	350	35	≥63								

Bestellbeispiel/Ordering example: 1 Stk./pcs. S16P PCLNR 09



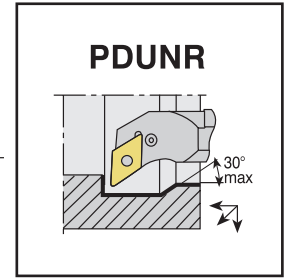
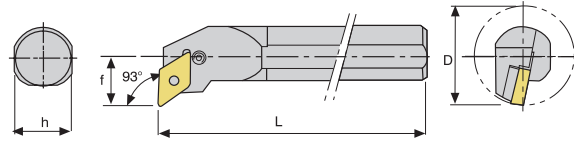

Bezeichnung Designation	Abmessungen (mm) Dimensions (mm)					Wendeplatte Insert	Ersatzteile Spare parts						
	d	h	L	f	D min		Hebel (H) Lever	Schraube für H Screw for lever	Unterlage (UL) Shim	Druckfeder für UL Pressure spring	Spannpratze Clamp	Spannschraube Clamping screw	Winkelschlüssel Allen key
<b>S20R PDUNR/L 11</b>	20	18	200	13	≥25	<b>DNM. 11 04..</b>							
<b>S25S PDUNR/L 11</b>	25	23	250	17	≥32								
<b>A20P PDUNR/L 11</b>	20	18	170	13	≥25								
<b>A25R PDUNR/L 11</b>	25	23	200	17	≥32								
<b>S32T PDUNR/L 15</b>	32	30	300	22	≥40	<b>DNM. 15 06..</b>							
<b>S40U PDUNR/L 15</b>	40	37	350	27	≥50								
<b>S50V PDUNR/L 15</b>	50	47	400	35	≥63								
<b>A32S PDUNR/L 15</b>	32	30	250	22	≥40								
<b>A40T PDUNR/L 15</b>	40	37	300	27	≥50								
<b>A50U PDUNR/L 15</b>	50	47	350	35	≥63								

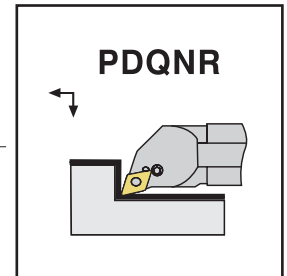
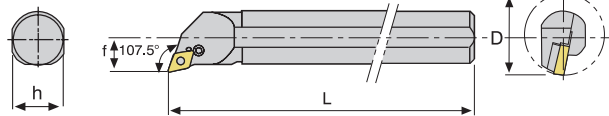

Bezeichnung Designation	Abmessungen (mm) Dimensions (mm)					Wendeplatte Insert	Ersatzteile Spare parts						
	d	h	L	f	D min		Hebel (H) Lever	Schraube für H Screw for lever	Unterlage (UL) Shim	Druckfeder für UL Pressure spring	Spannpratze Clamp	Spannschraube Clamping screw	Winkelschlüssel Allen key
<b>S20R PDQNR/L 11</b>	20	18	200	13	≥25	<b>DNM. 11 04..</b>							
<b>S25S PDQNR/L 11</b>	25	23	250	17	≥32								
<b>A20P PDQNR/L 11</b>	20	18	170	13	≥25								
<b>A25R PDQNR/L 11</b>	25	23	200	17	≥32								
<b>S32T PDQNR/L 15</b>	32	30	300	22	≥40	<b>DNM. 15 06..</b>							
<b>S40U PDQNR/L 15</b>	40	37	350	27	≥50								
<b>S50V PDQNR/L 15</b>	50	47	400	35	≥63								
<b>A32S PDQNR/L 15</b>	32	30	250	22	≥40								
<b>A40T PDQNR/L 15</b>	40	37	300	27	≥50								
<b>A50U PDQNR/L 15</b>	50	47	350	35	≥63								

Bestellbeispiel/Ordering example: 1 Stk./pcs. S20R PDQNR 11

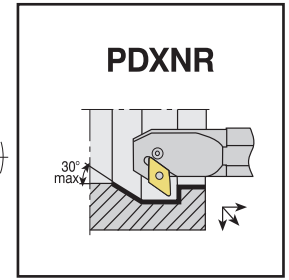
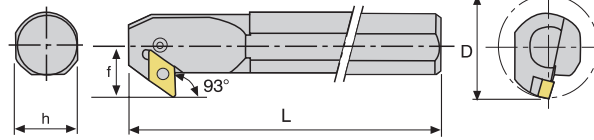

Bezeichnung Designation	Abmessungen (mm) Dimensions (mm)					Wendeplatte Insert	Ersatzteile Spare parts													
	d	h	L	f	D min		Hebel (H) Lever	Schraube für H Screw for lever	Unterlage (UL) Shim	Druckfeder für UL Pressure spring	Spannpratze Clamp	Spannschraube Clamping screw	Winkelschlüssel Allen key							
<b>S32T PDXNR/L 15</b>	32	30	300	25	≥45						-	-	017003							
<b>S40U PDXNR/L 15</b>	40	37	350	27	≥50									008003	009003	001030	010002	-	-	017003
<b>S50V PDXNR/L 15</b>	50	47	400	35	≥63															

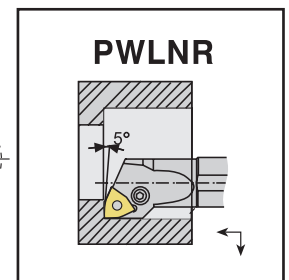
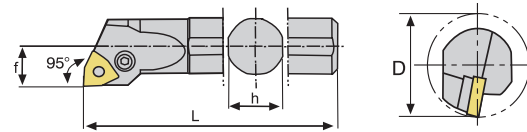

Bezeichnung Designation	Abmessungen (mm) Dimensions (mm)					Wendeplatte Insert	Ersatzteile Spare parts													
	d	h	L	f	D min		Hebel (H) Lever	Schraube für H Screw for lever	Unterlage (UL) Shim	Druckfeder für UL Pressure spring	Spannpratze Clamp	Spannschraube Clamping screw	Winkelschlüssel Allen key							
<b>S20R PWLNR/L 06</b>	20	18	200	13	≥25						-	-	017002							
<b>S25S PWLNR/L 06</b>	25	23	250	17	≥32									008001	009002	001018	010001	-	-	017002
<b>A20P PWLNR/L 06</b>	20	18	170	13	≥25															
<b>A25R PWLNR/L 06</b>	25	23	200	17	≥32															
<b>A32S PWLNR/L 06</b>	32	30	250	22	≥40															
<b>S25S PWLNR/L 08C</b>	25	23	250	17	≥32						002014	011032	017003							
<b>S32T PWLNR/L 08C</b>	32	30	300	22	≥40									008002	009003	001017	010002	002014	011032	017003
<b>S40U PWLNR/L 08C</b>	40	37	350	27	≥50															
<b>S50V PWLNR/L 08C</b>	50	47	400	35	≥63															
<b>A25R PWLNR/L 08C</b>	25	23	200	17	≥32															
<b>A32S PWLNR/L 08C</b>	32	30	250	22	≥40															
<b>A40T PWLNR/L 08C</b>	40	37	300	27	≥50															
<b>A50U PWLNR/L 08C</b>	50	47	350	35	≥63															

Bestellbeispiel/Ordering example: 1 Stk/pcs. S20R PWLNR 06

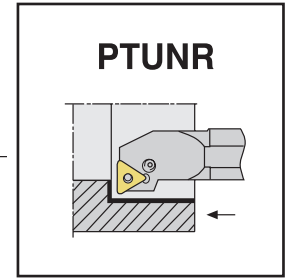
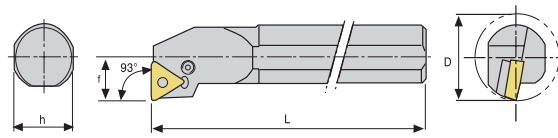

Bezeichnung Designation	Abmessungen (mm) Dimensions (mm)					Wendeplatte Insert	Ersatzteile Spare parts													
	d	h	L	f	D min		Hebel (H) Lever	Schraube für H Screw for lever	Unterlage (UL) Shim	Druckfeder für UL Pressure spring	Spannpratze Clamp	Spannschraube Clamping screw	Winkelschlüssel Allen key							
<b>S16P PTUNR/L 16</b>	16	15	170	11	≥21	<b>TNM. 16 04..</b>														
<b>S20R PTUNR/L 16</b>	20	18	200	13	≥25									009001	-	-				
<b>S25S PTUNR/L 16C</b>	25	23	250	17	≥32									008001	009002	001003	010001	-	-	017002
<b>S32T PTUNR/L 16C</b>	32	30	300	22	≥40									008001	009002	001003	010001	002014	011032	017002
<b>S40U PTUNR/L 16C</b>	40	37	350	27	≥50															
<b>S32T PTUNR/L 22C</b>	32	30	300	22	≥40	<b>TNM. 22 04..</b>														
<b>S40U PTUNR/L 22C</b>	40	37	350	27	≥50									008002	009003	001004	010002	-	-	017003
<b>S50V PTUNR/L 22C</b>	50	47	400	35	≥63									008002	009003	001004	010002	-	-	017003

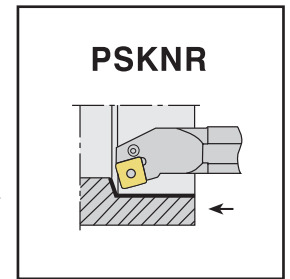
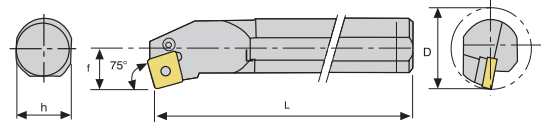

Bezeichnung Designation	Abmessungen (mm) Dimensions (mm)					Wendeplatte Insert	Ersatzteile Spare parts													
	d	h	L	f	D min		Hebel (H) Lever	Schraube für H Screw for lever	Unterlage (UL) Shim	Druckfeder für UL Pressure spring	Spannpratze Clamp	Spannschraube Clamping screw	Winkelschlüssel Allen key							
<b>S25S PSKNR/L 12C</b>	25	23	250	17	≥32	<b>SNM. 12 04..</b>														
<b>S32T PSKNR/L 12C</b>	32	30	300	22	≥40									008002	009003	001023	010002	002014	011032	017003
<b>S40U PSKNR/L 12C</b>	40	37	350	27	≥50									008002	009003	001023	010002	002014	011032	017003
<b>S50V PSKNR/L 12C</b>	50	47	400	35	≥63															
<b>S32T PSKNR/L 15</b>	32	30	300	22	≥40									<b>SNM. 15 06..</b>						
<b>S40U PSKNR/L 15</b>	40	37	350	27	≥50	008004	009004	001024	010003	-	-	017004								
<b>S50V PSKNR/L 15</b>	50	47	400	35	≥63	008004	009004	001024	010003	-	-	017004								

Bestellbeispiel/Ordering example: 1 Stk/pcs. S25S PSKNR 12C

Gewindedrehhalter für die Innen- und Außenbearbeitung/  
*Threading toolholders for internal and external machining*

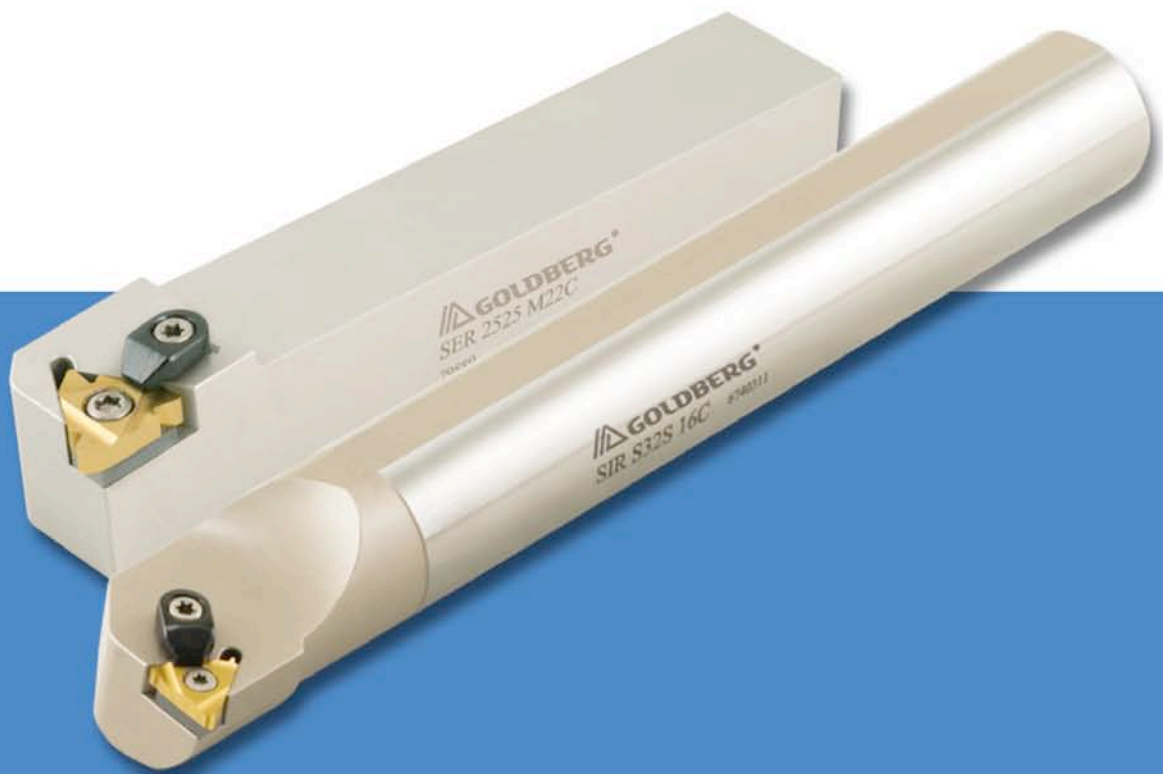

**S** **E** **R** **25 25** **M** **16** **C**

1 2 3 4-5 6 7 8

**1** Art der Schneidplattenbefestigung /  
Type of insert mounting

S: Über die Bohrung geschraubt  
S: Screw Clamping

**2** Werkzeugausführung /  
Tool version

E: Außen / External  
I: Innen / Internal

**3** Schaftausführung /  
Shaft version

R: Rechts - / Right - Hand  
L: Links - / Left - Hand

**4** Grundform der Wendeschneidplatte / Basic shape of indexable insert

A: Vollstahlausführung mit innere Kühlmittelzufuhr / Solid steel design with internal coolant supply  
E: Hartmetallschaft mit Kopf aus Stahl und innere Kühlmittelzufuhr / Carbide shank with steel head and supply internal coolant  
C: Hartmetallschaft mit Kopf aus Stahl ohne innere Kühlmittelzufuhr / Carbide shank with steel head and without internal coolant supply  
S: Vollstahlausführung ohne innere Kühlmittelzufuhr / Solid steel design without internal coolant supply

**4-5** Schaftabmessung / Shank size

Schaft : hxb / Shank : hxb  
2525 - 25 x 25 mm

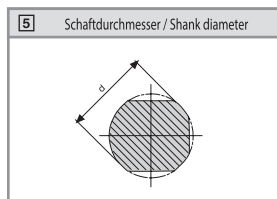

**6** Drehhalterlänge (mm) / Turning toolholder length (mm)

A - 32	H - 100	Q - 180	x-special
B - 40	J - 110	R - 200	
C - 50	K - 125	S - 250	
D - 60	L - 140	T - 300	
E - 70	M - 150	U - 350	
F - 80	N - 160	V - 400	
G - 90	P - 170	W - 450	

**7** Wendeplattengröße /  
Insert size



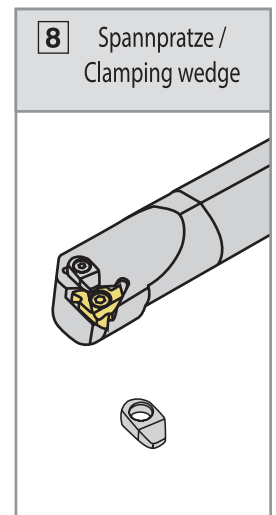



l (mm)	d
06	5/32"
08	3/16"
11	1/4"
16	3/8"
22	1/2"
27	5/8"

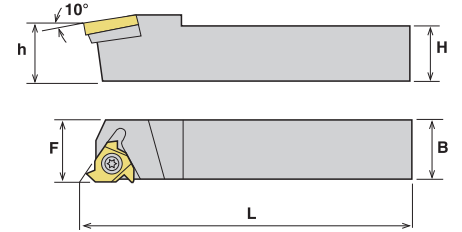
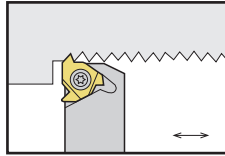

**S** **I** **R** **S** **25** **R** **16** **C**

1 2 3 4 5 6 7 8



Bezeichnung Designation	Abmessungen (mm) Dimensions (mm)				Wendeplatte Insert	Ersatzteile Spare parts					
	h=H	B	L	F		Spannschraube Clamping screw	Unterlage (UL) Shim	Schraube für UL Screw for shim	Spannpratze Wedge clamp	Spannschraube Clamping screw	Torx Schlüssel Torx key
											
SER/L 0808 E 11	08	08	70	11	11 ER/EL	011007	-	-	-	-	018003
SER/L 1010 E 11	10	10	70	11							
SER/L 1616 H 11	16	16	100	16							
SER/L 1616 H 16C	16	16	100	16	16 ER/EL	011042	001005	004006	002014	011032	018005
SER/L 2020 K 16C	20	20	125	20							
SER/L 2525 M 16C	25	25	150	25							
SER/L 3232 P 16C	32	32	170	32							
SER/L 2525 M 22C	25	25	150	25	22 ER/EL	011037	001006	004007			018006
SER/L 3232 P 22C	32	32	170	32							
SER/L 4040 S 22C	40	40	250	40							
SER/L 2525 M 16C-T	25	25	150	25	16 ER/L (1.5-3 TR)	011014	-	-			018005
SER/L 2525 M 22C-T	25	25	150	25	22 ER/L (4-6 TR)	011037	-	-			018006

Bestellbeispiel/Ordering Example: 1 Stk/pcs. SER 0808 E11



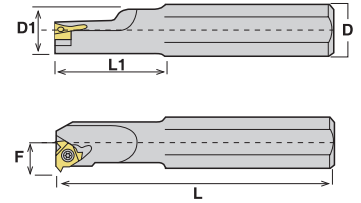
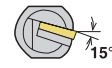
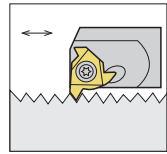

Bezeichnung Designation	Abmessungen (mm) Dimensions (mm)						Wendeplatte Insert	Ersatzteile Spare parts						
	D	D1	L	L1	F	D min		Spannschraube Clamping screw	Unterlage (UL) Shim	Schraube für UL Screw for shim	Spannpratze Wedge clamp	Spannschraube Clamping screw	Torx Schlüssel Torx key	
SIR/L S16X07M 08	16	07	150	18	5.3	7.8	08 IR/L	011004	-	-	-	-	-	018002
SIR/L S10H 11	10	10	100	-	7.4	12	11 IR/L	011007	-	-	-	-	-	018003
SIR/L S12K 11	12	12	125	-	8.4	16								
SIR/L S16X10M 11	16	10	150	25	7.4	12								
SIR/L S16X13M 11	16	13	150	32	8.9	15								
SIR/L S16X13M 16	16	13	150	32	10.2	16	16 IR/L	011014	-	-	-	-	-	018005
SIR/L S16M 16	16	16	150	-	11.7	19								
SIR/L S20X16P 16	20	16	170	40	11.7	19								
SIR/L S20P 16	20	20	170	-	13.7	24								
SIR/L S25R 16C	25	25	200	-	16.2	29								
SIR/L S32S 16C	32	32	250	-	19.7	36								
SIR/L S40T 16C	40	40	300	-	23.7	44	22 IR/L	011037	001006	004007	002014	011032	018006	
SIR/L S50U 16C	50	50	350	-	28.7	54								
SIR/L S20P 22	20	20	170	-	14	24								
SIR/L S25R 22C	25	25	200	-	18.1	29								
SIR/L S32S 22C	32	32	250	-	21.6	38	16 IR/L (1.5-3 TR)	011014	-	-	-	-	018005	
SIR/L S40T 22C	40	40	300	-	25.6	46								
SIR/L S50U 22C	50	50	350	-	30.6	58	22 IR/L (4-6 TR)	011037	-	-	-	-	018006	
SIR/L S25R 16C-T	25	25	200	-	16.2	29								
SIR/L S32S 16C-T	32	32	250	-	19.7	36								
SIR/L S25R 22C-T	25	25	200	-	18.1	29								
SIR/L S32S 22C-T	32	32	250	-	21.6	38								

Bestellbeispiel/Ordering Example: 1 Stk/pcs. SIR S16X07M 08

# Kurzklemmhalter / *Cartridges*



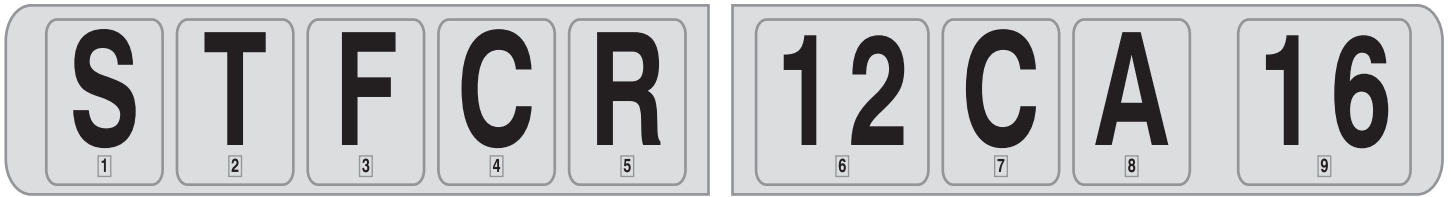



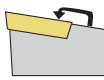
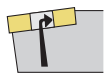
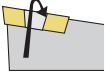

**1** Art der Schneidplattenbefestigung / Type of insert mounting

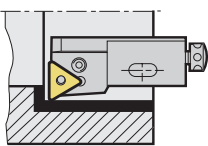
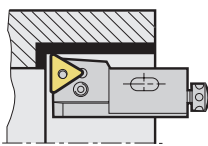
 von oben gespannt/ top clamping	 über die Bohrung gespannt/ hole clamping	 über die Bohrung geschraubt/ screw clamping
<b>C</b>	<b>P</b>	<b>S</b>

**5** Drehhalterauführung / Orientation of turning toolholder

	
<b>R</b>	<b>L</b>

**2** Grundform der Wendeschneidplatte / Basic shape of indexable insert

		
<b>C</b>	<b>S</b>	<b>T</b>

**6** Drehhalterhöhe (mm) / Turning toolholder height (mm)

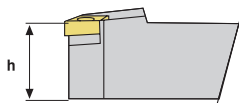

**3** Anstellwinkel / Approach angle

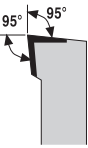
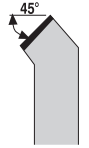
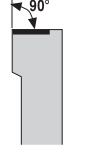
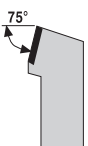
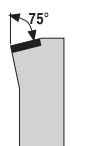
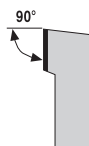
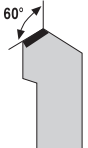
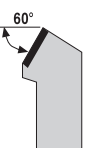
 <b>L</b>	 <b>S</b>	 <b>F</b>
 <b>R</b>	 <b>K</b>	 <b>G</b>
 <b>W</b>	 <b>T</b>	



**7** Kennzeichen für Kurzklemmhalter / Cartridge code

**C**  
(Kurzklemmhalter / Cartridge)

**8** Art des Kurzklemmhalters / Type of cartridge

**A**  
(ISO 5611)

**4** Freiwinkel der Wendeschneidplatte / Indexable insert clearance angle

 <b>C</b>	 <b>P</b>	 <b>N</b>
---	---	---

**9** Länge der Schneidkante (mm) / Length of cutting edge (mm)

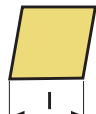
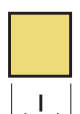
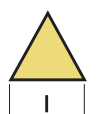
		
--	---	---

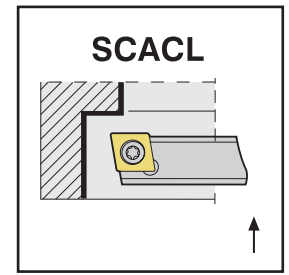
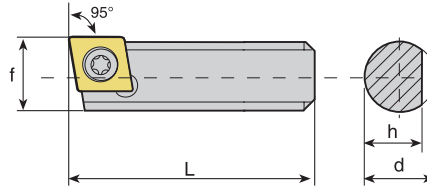

Bezeichnung Designation	Abmessungen (mm) Dimensions (mm)				Wendeplatte Insert	Ersatzteile Spare parts	
	d	h	L	f		Spannschraube Clamping screw	Torx Schlüssel Torx key
<b>S10X SCACR/L 06</b>	10	8.5	25	10.5			
<b>S10A SCACR/L 06</b>	10	8.5	32	10.5			
<b>S10C SCACR/L 06</b>	10	8.5	50	10.5			
<b>S12B SCACR/L 06</b>	12	10.5	40	12.5			
<b>S16A SCACR/L 09</b>	16	14	32	16.5			
<b>S16B SCACR/L 09</b>	16	14	40	16.5			
<b>S16C SCACR/L 09</b>	16	14	50	16.5			
<b>S16D SCACR/L 09</b>	16	14	60	16.5			
<b>S16E SCACR/L 09</b>	16	14	70	16.5			
<b>S16G SCACR/L 09</b>	16	14	90	16.5			
<b>S16H SCACR/L 09</b>	16	14	100	16.5			

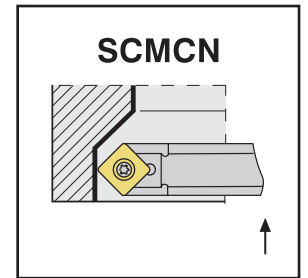
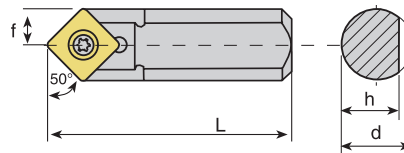

Bezeichnung Designation	Abmessungen (mm) Dimensions (mm)				Wendeplatte Insert	Ersatzteile Spare parts	
	d	h	L	f		Spannschraube Clamping screw	Torx Schlüssel Torx key
<b>S10X SCMCN 06</b>	10	8.5	25	5			
<b>S16C SCMCN 09</b>	16	14	50	8			
<b>S16D SCMCN 09</b>	16	14	60	8			
<b>S16D SCMCN 09-R</b>	16	14	60	8			
<b>S16D SCMCN 09-L</b>	16	14	60	8			

Bestellbeispiel/Ordering example: 1 Stk/pcs. S10X SCMCN 06

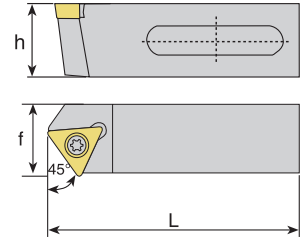



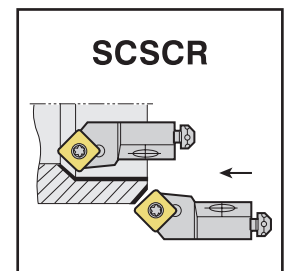
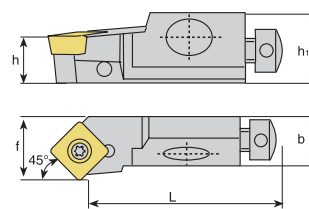
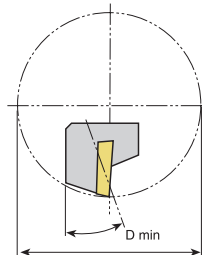
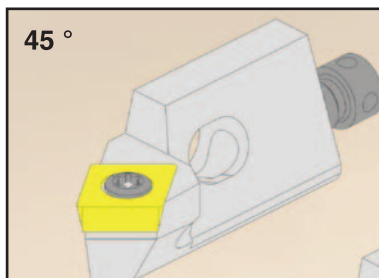



Bezeichnung Designation	Abmessungen (mm) Dimensions (mm)				Wendeplatte Insert	Ersatzteile Spare parts	
	d	h	L	f		Spannschraube Clamping screw	Torx Schlüssel Torx key
<b>STXCR/L 2020 B16</b>	20	20	40	20			
<b>STXCR/L 2020 E16</b>	20	20	70	20	<b>TCM. 16T3..</b>	<b>011014</b>	<b>018005</b>

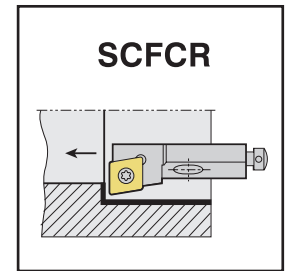
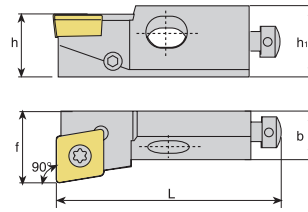
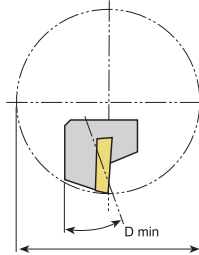





Bezeichnung Designation	Abmessungen (mm) Dimensions (mm)							Wendeplatte Insert	Ersatzteile Spare parts			
	h	h <sub>1</sub>	b	L	f	D min	Unterlage Shim		Schraube für Unterlage Screw for shim	Spannschraube Clamping screw	Torx Schlüssel Torx key	
<b>SCSCR/L 06CA 06</b>	6	8	6	21	8	≥20		-	-			
<b>SCSCR/L 10CA 09</b>	10	15	11	44	14	≥40	<b>CCM. 09T3..</b>	<b>001011</b>	<b>004006</b>	<b>011042</b>	<b>018005</b>	
<b>SCSCR/L 12CA 12</b>	12	18	15	47	20	≥50	<b>CCM. 1204..</b>	<b>001012</b>	<b>004007</b>	<b>011037</b>	<b>018006</b>	

Bestellbeispiel/Ordering example: 1 Stk/pcs. SCSCR 06CA 06

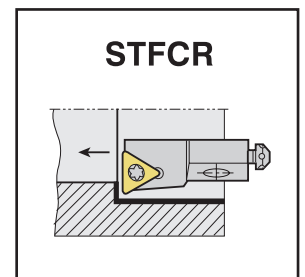
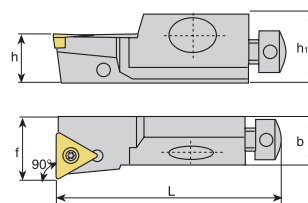
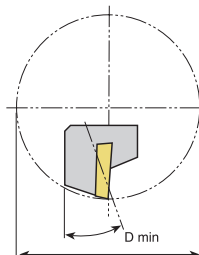

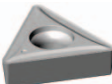

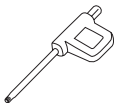

Bezeichnung Designation	Abmessungen (mm) Dimensions (mm)							Wendeplatte Insert 	Ersatzteile Spare parts			
	h	h <sub>1</sub>	b	L	f	D min	Unterlage Shim		Schraube für Unterlage Screw for shim	Spannschraube Clamping screw	Torx Schlüssel Torx key	
												
<b>SCFCR/L 06CA 06</b>	6	8.5	6	25	8	≥20	<b>CCM. 0602..</b>	-	-	011007	018003	
<b>SCFCR/L 08CA 06</b>	8	11	8	32	10	≥20		-	-	011014	018005	
<b>SCFCR/L 10CA 09</b>	10	15	11	50	14	≥40	<b>CCM. 09T3..</b>	-	-	011014	018005	
<b>SCFCR/L 12CA 12</b>	12	18	15	55	20	≥50		001012	004007	011037	018006	
<b>SCFCR/L 16CA 12</b>	16	21	20	63	25	≥60		001012	004007	011037	018006	



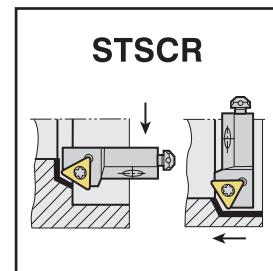
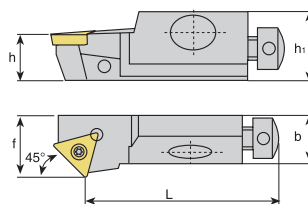
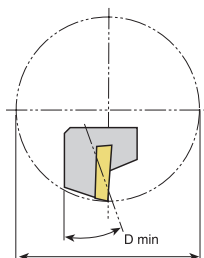

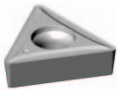

Bezeichnung Designation	Abmessungen (mm) Dimensions (mm)							Wendeplatte Insert 	Ersatzteile Spare parts			
	h	h <sub>1</sub>	b	L	f	D min	Unterlage Shim		Schraube für Unterlage Screw for shim	Spannschraube Clamping screw	Torx Schlüssel Torx key	
												
<b>STFCR/L 10CA 11</b>	10	15	11	50	14	≥40	<b>TCM. 1102..</b>	-	-	011007	018003	
<b>STFCR/L 12CA 16</b>	12	20	15	55	20	≥50		-	-	011014	018005	
<b>STFCR/L 16CA 16</b>	16	21	20	63	20	≥60	<b>TCM. 16T3..</b>	001001	004006	011042	018005	

Bestellbeispiel/Ordering example: 1 Stk./pcs. STFCR 10CA 11

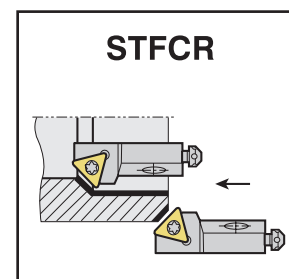
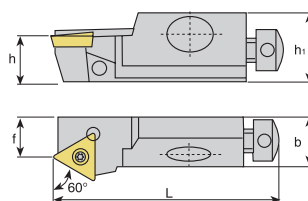
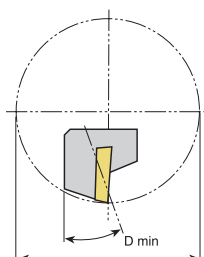
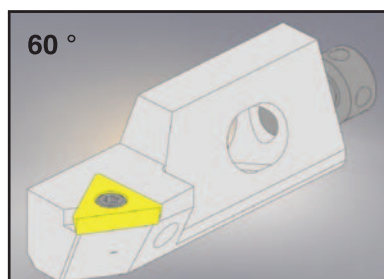

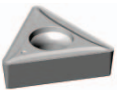
Bezeichnung Designation	Abmessungen (mm) Dimensions (mm)						Wendeplatte Insert 	Ersatzteile Spare parts			
	h	h <sub>1</sub>	b	L	f	D min		Unterlage Shim	Schraube für Unterlage Screw for shim	Spannschraube Clamping screw	Torx Schlüssel Torx key
											
<b>STSCR/L 08CA 09</b>	8	11	8	28	10	≥20	TCM. 0902..	-	-	011004	018002
<b>STSCR/L 10CA 11</b>	10	15	11	44	14	≥40	TCM. 1102..	-	-	011007	018003

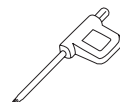

Bezeichnung Designation	Abmessungen (mm) Dimensions (mm)						Wendeplatte Insert 	Ersatzteile Spare parts			
	h	h <sub>1</sub>	b	L	f	D min		Unterlage Shim	Schraube für Unterlage Screw for shim	Spannschraube Clamping screw	Torx Schlüssel Torx key
											
<b>STTCR/L 08CA 09</b>	8	9,5	6,5	25,7	10	≥20	TCM. 0902..	-	-	011004	018002
<b>STTCR/L 10CA 11</b>	10	15	11	42	13,9	≥40	TCM. 1102..	-	-	011007	018003

Bestellbeispiel/Ordering example: 1 Stk/pcs, STTCR 08CA 09



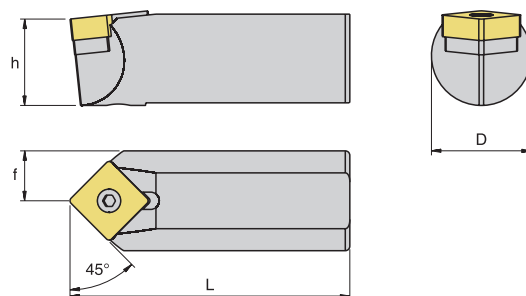

Bezeichnung Designation	Abmessungen (mm) Dimensions (mm)				Wendeplatte Insert	Ersatzteile Spare parts				
	d	h	L	f		Unterlage Shim	Spannschraube Clamping screw	Spannpratze Clamp	Spannschraube Clamping screw	Winkelschlüssel Allen key
<b>S22D PSDNN 12C</b>	22	19.5	60	11						
					<b>SNM. 1204..</b>	001027	013001	002014	011032	017002

Bestellbeispiel/Ordering example: 1 Stk./pcs. SS22D PSDNN 12C